

What's New in



CAMWorks



Geometric Americas Inc. makes no warranties, either expressed or implied with respect to this document. Geometric reserves the right to revise and improve products as it sees fit, and to revise the specifications and information contained herein without prior notice. Due to continuing product development, specifications and capabilities described in this document are subject to change without notice.

Copyright © 2021-2022 Geometric Americas Inc. All Rights Reserved.

September 2022



Table of Contents

(Click a link below or use the bookmarks on the left.)

What’s New in CAMWorks 2022 SP4	3
Supported Platforms	3
Resolved CPRs Document	3
What’s New in CAMWorks 2022 SP3	4
Supported Platforms	4
Resolved CPRs Document	4
What’s New in CAMWorks 2022 SP2	5
Supported Platforms	5
Resolved CPRs Document	5
What’s New in CAMWorks 2022 SP1	6
Supported Platforms	6
Resolved CPRs Document	6
What’s New in CAMWorks 2022 SP0	7
Supported Platforms	7
Resolved CPRs Document	7
General	8
Speed Improvements for Post Processing	8
Operations Header in Post Process UI when Post Processing in Fast Mode	8
Mill	9
Barrel Tool Support for Mill Operations	9
Gouge Checking Option for Automatic Tilt Relative to Direction of Cut for Multiaxis Mill Operations	12
Interface to Define and Modify Multisurface features from Operation Parameters Dialog Box	14
Enhanced ‘Machine to Mean’ function for Contour Mill Operations to achieve Maximum Material Condition	16
Option to Convert Rapid Moves to High Feed Moves for VoluMill Toolpaths	19
Option to Convert Arc Moves to Line Moves for VoluMill Toolpaths	20
Intuitive Nomenclature for CNC Finish Parameters in NC tab of 2 Axis Mill Operations	21
Leadin/Out Move Calculation And Display For Contour Mill Operations With CNC Toolpath Compensation	22
License	23
License Activation Method: Online Activation using Activation IDs	23



What's New in CAMWorks 2022 SP4

Supported Platforms

Supported Platforms for 64-bit	
Solid Modeler:	The 64-bit version of: <ul style="list-style-type: none"> - SOLIDWORKS 2022 - SOLIDWORKS 2021 - CAMWorks Solids 2022 - CAMWorks Solids 2021
Operating System:	64-bit version of: <ul style="list-style-type: none"> - Windows 11 - Windows 10 - Windows 8.1 - Windows 7 (SP1 or higher) <p style="text-align: right;">[*Home Editions are not supported]</p> <p>Note: CAMWorks 2022 is supported only on 64-bit Operating systems.</p>

Resolved CPRs Document

Purpose of Document:	The Resolved CPR (<i>CAMWorks Problem Report</i>) document has been updated to report the software errors that have been resolved in the current Service Pack (SP4).
Path to Document:	To view the document, select: C:\Program Files\CAMWorks2022x64\CAMWorks_VC142\Lang\English\CW2022BuildInfo.pdf



What's New in CAMWorks 2022 SP3

Supported Platforms

Supported Platforms for 64-bit	
Solid Modeler:	The 64-bit version of: <ul style="list-style-type: none"> - SOLIDWORKS 2022 - SOLIDWORKS 2021 - CAMWorks Solids 2022 - CAMWorks Solids 2021
Operating System:	64-bit version of: <ul style="list-style-type: none"> - Windows 10 - Windows 8.1 - Windows 7 (SP1 or higher) <p style="text-align: right;">[*Home Editions are not supported]</p> <p>Note: CAMWorks 2022 is supported only on 64-bit Operating systems.</p>

Resolved CPRs Document

Purpose of Document:	The Resolved CPR (<i>CAMWorks Problem Report</i>) document has been updated to report the software errors that have been resolved in the current Service Pack (SP3).
Path to Document:	To view the document, select: C:\Program Files\CAMWorks2022x64\CAMWorks_VC142\Lang\English\CW2022BuildInfo.pdf



What's New in CAMWorks 2022 SP2

Supported Platforms

Supported Platforms for 64-bit	
Solid Modeler:	The 64-bit version of: <ul style="list-style-type: none"> - SOLIDWORKS 2022 - SOLIDWORKS 2021 - CAMWorks Solids 2022 - CAMWorks Solids 2021
Operating System:	64-bit version of: <ul style="list-style-type: none"> - Windows 10 - Windows 8.1 - Windows 7 (SP1 or higher) <p style="text-align: right;">[*Home Editions are not supported]</p> <p>Note: CAMWorks 2022 is supported only on 64-bit Operating systems.</p>

Resolved CPRs Document

Purpose of Document:	The Resolved CPR (<i>CAMWorks Problem Report</i>) document has been updated to report the software errors that have been resolved in the current Service Pack (SP2).
Path to Document:	To view the document, select: C:\Program Files\CAMWorks2022x64\CAMWorks_VC142\Lang\English\CW2022BuildInfo.pdf



What's New in CAMWorks 2022 SP1

Supported Platforms

Supported Platforms for 64-bit	
Solid Modeler:	The 64-bit version of: <ul style="list-style-type: none"> - SOLIDWORKS 2022 - SOLIDWORKS 2021 - CAMWorks Solids 2022 - CAMWorks Solids 2021
Operating System:	64-bit version of: <ul style="list-style-type: none"> - Windows 10 - Windows 8.1 - Windows 7 (SP1 or higher) <p style="text-align: right;">[*Home Editions are not supported]</p> <p>Note: CAMWorks 2022 is supported only on 64-bit Operating systems.</p>

Resolved CPRs Document

Purpose of Document:	The Resolved CPR (<i>CAMWorks Problem Report</i>) document has been updated to report the software errors that have been resolved in the current Service Pack (SP1).
Path to Document:	To view the document, select: C:\Program Files\CAMWorks2022x64\CAMWorks_VC142\Lang\English\CW2022BuildInfo.pdf



What's New in CAMWorks 2022 SP0

Supported Platforms

Supported Platforms for 64-bit	
Solid Modeler:	The 64-bit version of: <ul style="list-style-type: none"> - SOLIDWORKS 2022 - SOLIDWORKS 2021 - CAMWorks Solids 2022 - CAMWorks Solids 2021
Operating System:	64-bit version of: <ul style="list-style-type: none"> - Windows 10 - Windows 8.1 - Windows 7 (SP1 or higher) <p style="text-align: right;">[*Home Editions are not supported]</p> <p>Note: CAMWorks 2022 is supported only on 64-bit Operating systems.</p>

Resolved CPRs Document

Purpose of Document:	The Resolved CPR (<i>CAMWorks Problem Report</i>) document has been updated to report the software errors that have been resolved in the current Service Pack (SP0).
Path to Document:	To view the document, select: <i>C:\Program Files\CAMWorks2022x64\CAMWorks_VC141\Lang\English\CW2022BuildInfo.pdf</i>



General

Improved - Speed Improvements for Post Processing

Purpose:

To enable speedier post processing of parts and assemblies programmed using the CAMWorks application

Implementation:









Multiple minor changes have been internally implemented within the post processing function of the CAMWorks application to ensure optimization of codes for individual routines. The optimized code will result in significant speed improvements for post processing.

New - Operations Header in Post Process UI when Post Processing in Fast Mode

Purpose:

To provide an enhanced user interaction when Post Processing using the **Fast**  option

Implementation:

In the **Post Process** user interface (displayed on executing the **Post Process** command), the list box named **NC Code** displayed the NC code being generated when the **Step** , **Play**  or **Fast**  commands in the **Control bar** of the user interface were executed. The NC Code displayed within the list box made sense when the code was generated step by step using the **Step**  command or using the **Play**  button (unless code generation was paused  or stopped ). When processed using the **Fast**  command, the NC code displayed in the list box couldn't be read due to the high speed in which the code was generated.

From **CAMWorks 2022** version onwards, a new label named **Operations** will be displayed above the list box when the NC code is generated in **Fast**  mode. The list box will the name of the operations for which NC code has been generated within this list box. The Post Processing Completed' message will be displayed after successful post processing. (NC code generated can be viewed in the **Step** and **Play** modes.)

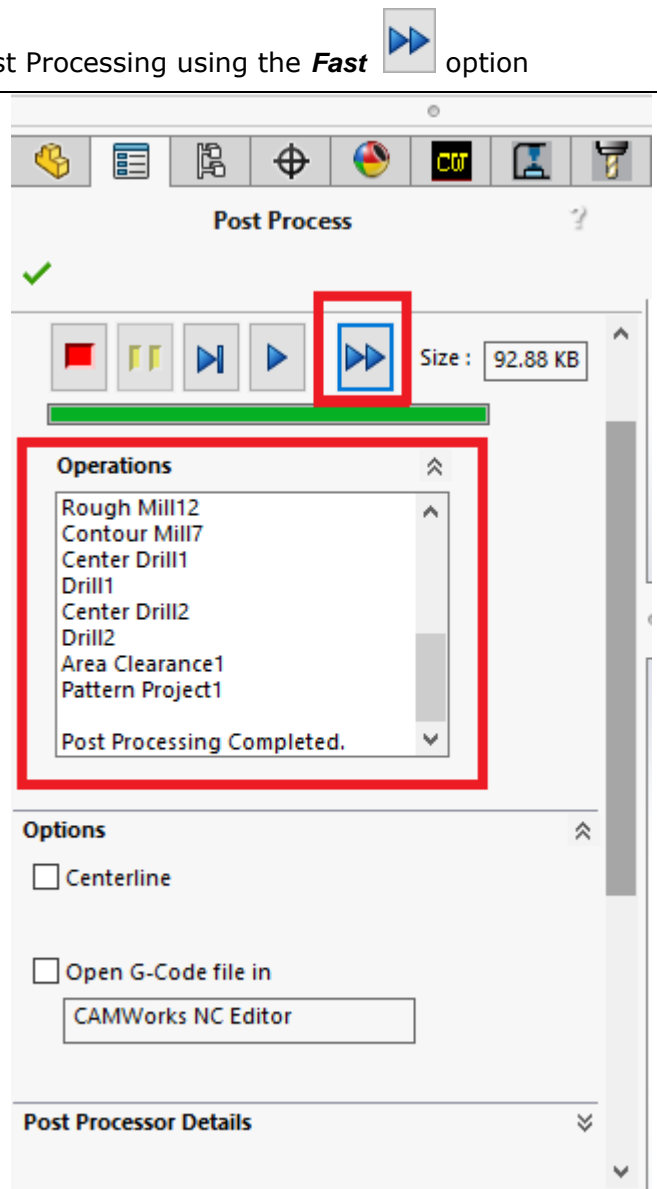

New 'Operations' Header in Post Process User Interface



Mill

New - Barrel Tool Support for Mill Operations

Purpose:

To support Barrel Tools for Milling Operations

Implementation:

Barrel Tool

The Barrel Tool is a cutting tool with specific shape comprising several arc segments. This shape can be parametrically defined. Barrel tools are preferred over conventional Ball Nose Mill tools for Mill finishing operations as the larger area of contact provided by the Barrel tool results in better surface finish.

Mill Operations for which Barrel Tools are Supported

- 2.5 Axis Mill Operations (Except Center Drill, Countersink, Tapping, Thread Milling and VoluMill operations)
- 3 Axis Mill Operations (Supported only when the Toolpath Generation Method in CAMWorks Options dialog box is set to 'Advanced')
- Multiaxis Mill Operations

Note: If a Barrel tool is assigned to an unsupported Mill operation, then a bubble pop-up warning message will immediately be displayed within the CAMWorks user interface indicating that the selected tool is not supported for the specific operation and will prompt you to select another tool.

Barrel Tool Types

The five types of Barrel tool supported in CAMWorks are:

- Standard
- Conical Tangent
- Tapered
- Lens
- Advanced

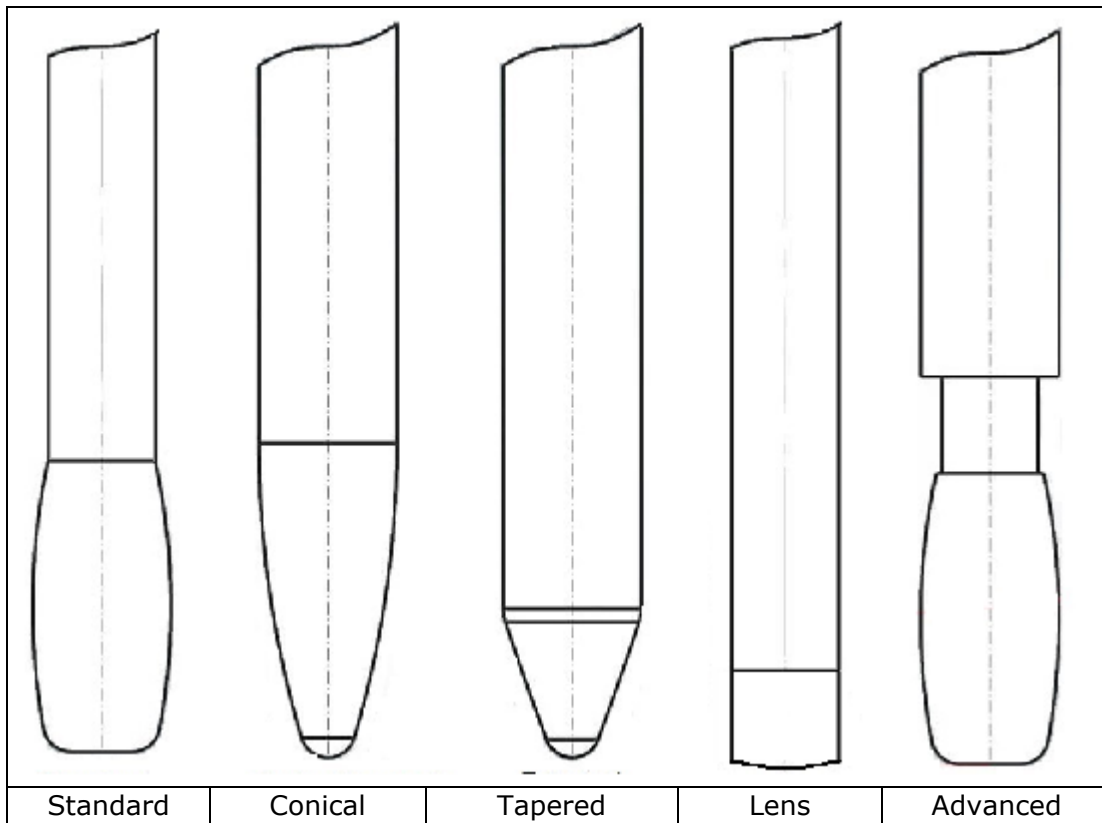



Viewing, Adding, Updating and Saving Barrel Tools in the Technology Database

The Technology Database shipped with CAMWorks comes equipped with a few Barrel tools. Barrel Tools can be accessed within the Technology Database App by selecting **Mill Tooling>>Cutters>>Barrel Tools**. The Barrel Tool interface displayed on selecting the specific Barrel tool type will display all the Barrel tools of that specific Barrel tool type currently saved within the Technology Database. You can view, add, edit, and save Barrel tools using the Barrel Tool interface. All such tools saved within the Technology Database linked to the CAMWorks application will be available for tool selection in the CAMWorks user interface.

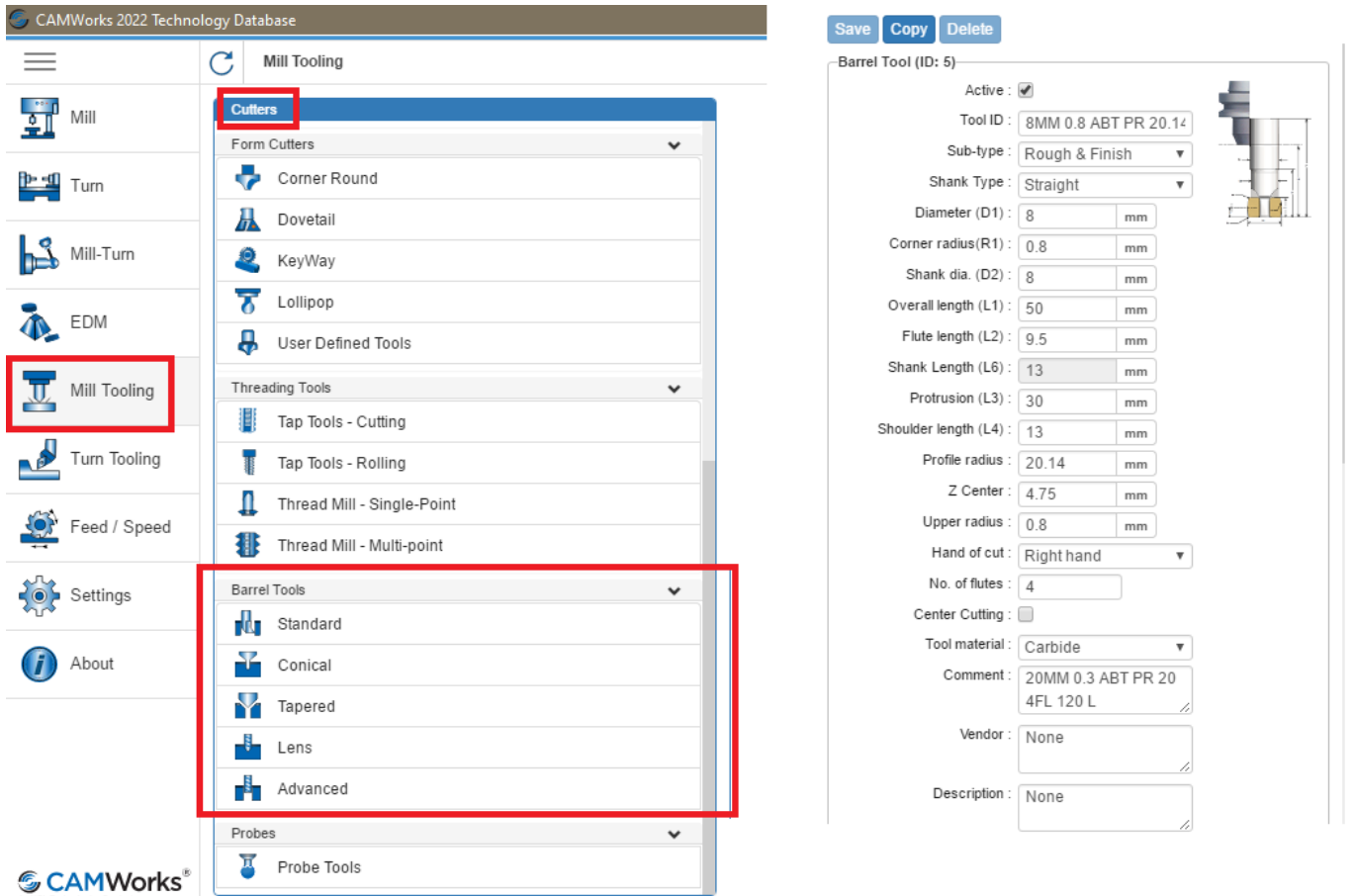

Barrel Tool Options under Cutters sub-menu of the Mill Tooling Menu

Barrel Tool form in the Barrel Tool user interface of TehDB App

User Interface for Barrel Tools in CAMWorks Application

Barrel tools can be viewed, added, edited, and saved in the following user interfaces:

- i. In the **Barrel Tool** page under Tool Tab of the **Operation Parameters** dialog box
- ii. Under **Barrel Tool** tab of **Edit Tool Parameters** dialog box

Within this user interface, the desired Barrel Tool type can be selected by selecting the corresponding option in the **Tool type** dropdown list. Based on the tool type selected, the parametric definition of the selected tool will be displayed under the **Tool Dimensions** group box.

Some of the major parameters are:

- **Max Diameter:** It is the maximum diameter across the flute length of the barrel tool. Use this parameter to assign/edit the full diameter of the Barrel tool.
- **Corner Radius:** Use this parameter to assign/edit the radius at the tip or corner of the barrel tool. You specify can be any value greater than zero but less than or equal to the Max diameter of the tool.

The parametric values that define the tool shape can be modified as desired. However, ensure that



the values assigned to the parameters defining the barrel tool profile adhere to the tool geometry. In case one or more assigned values result in incorrect tool geometry, then you will be notified through a bubble pop-up message that there was an error in creating the tool geometry and that values assigned to parameters highlighted in the user interface need to be revalidated.

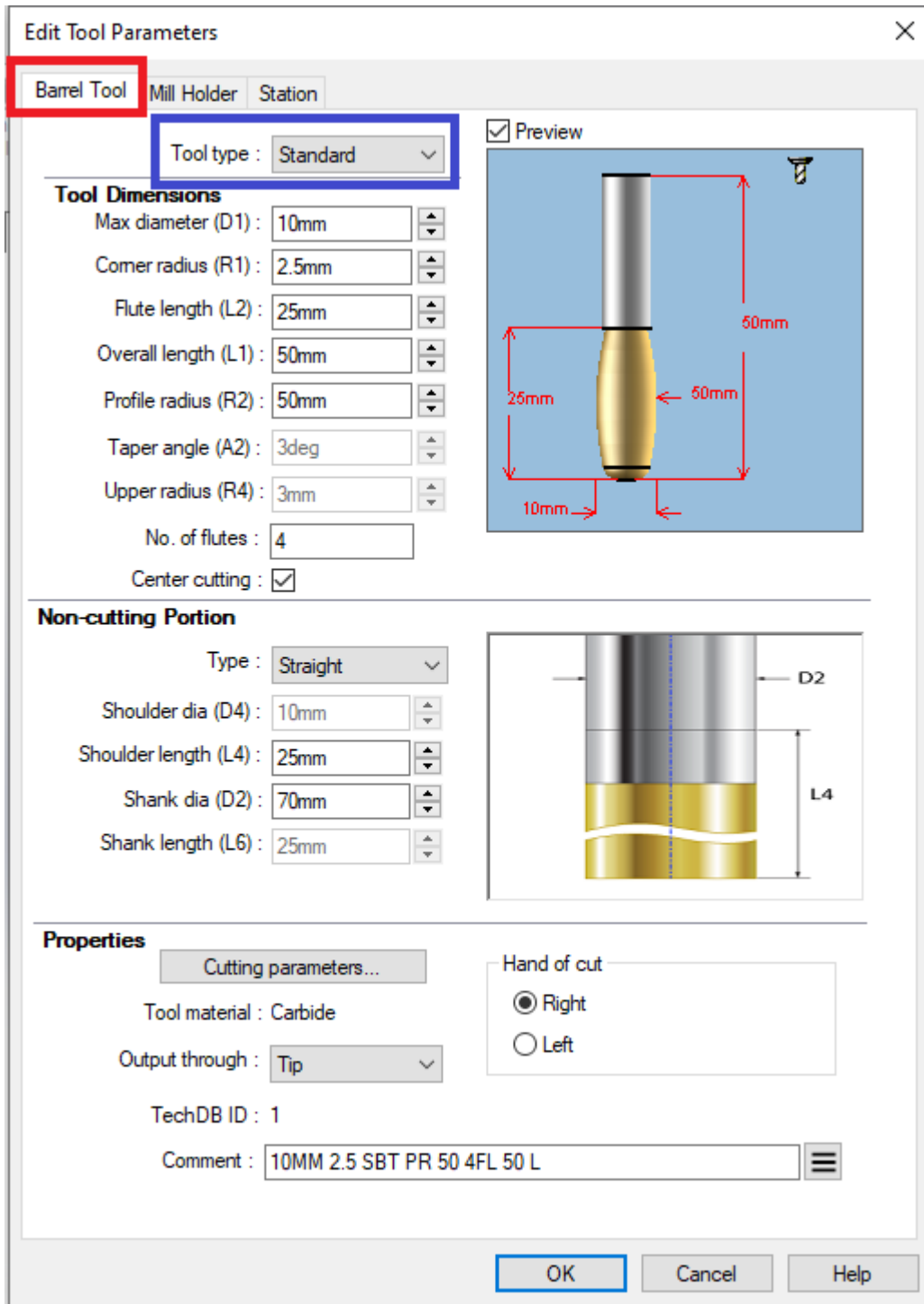

Barrel Tool Tab under Edit Tool Parameters Dialog Box

Barrel Tool Related Filters in Tool Select Filter Dialog Box

Barrel Tools can now be filtered, identified, and added to Tool cribs using the **Tool Select Filter** dialog box.

Barrel Tool is now one of the tool types listed in the **Tool type** dropdown list of this dialog box. If this option is selected in the **Tool type** dropdown list, then the checkbox labelled **Barrel Type** becomes active and will be checked by default. Use the dropdown list adjacent to this checkbox to select the Barrel tool type (viz. Standard, Conical, Tapered, Lens or Advanced). Based on the selection made,



all the Barrel tools of the selected barrel tool type available in the linked TechDB will be displayed.

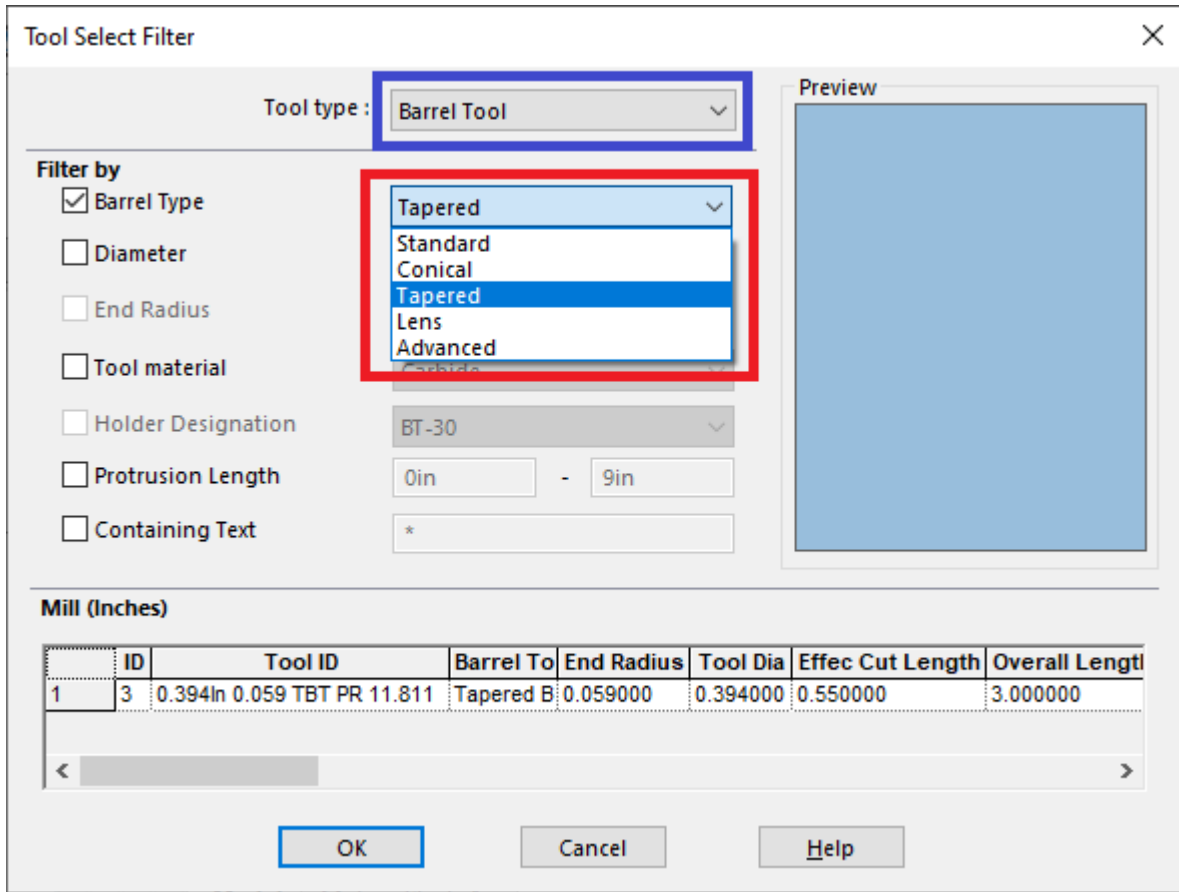

Tool Select Filter Dialog Box with filters related to Barrel Tool

New - Gouge Checking Option for Automatic Tilt Relative to Direction of Cut for Multiaxis Mill Operations

Purpose:

To support a new gouge checking option for Automatic tilt relative to Direction of Cut for Multiaxis Mill operations

Implementation:

In previous versions of CAMWorks, for Multiaxis Mill operations, the Automatic tilt was always relative to the Rotary axis.

From CAMWorks 2022 version onwards, an additional option will be available for Automatic tilt. Users will be able to select the whether the Automatic tilt is relative to one of the following two options:

- Direction of Cut
- Rotary Axis

Mill Tools for which the Automatic Tilt Options are Supported

The **Rotary Axis** option is supported for all Mill tool types except Barrel tools. If the tool assigned for the Multiaxis Mill operation is a Barrel tool, then the **Rotary Axis** option will not be available in the user interface. CAMWorks will automatically assign the **Direction of Cut** option for Automatic tilt.



What happens when the Automatic Tilt is relative to the 'Direction of Cut'?

When the *Direction of Cut* option is selected in the **Gouge Checking** tab of a Multiaxis Mill operation, collisions can be avoided by changing the *Lead/Lag* and/or *Side tilt* along each cut. The preference for lead/lag or side tilt can be specified in the **Preferences** group box. The minimum maximum range for **Lead tilt** and/or **Side tilt** can be specified in the **Limits** group box. To specify the range, place a check in the applicable checkbox (**Lead tilt/ Side tilt**). This action will enable the range fields. Assign the desired range in these fields.

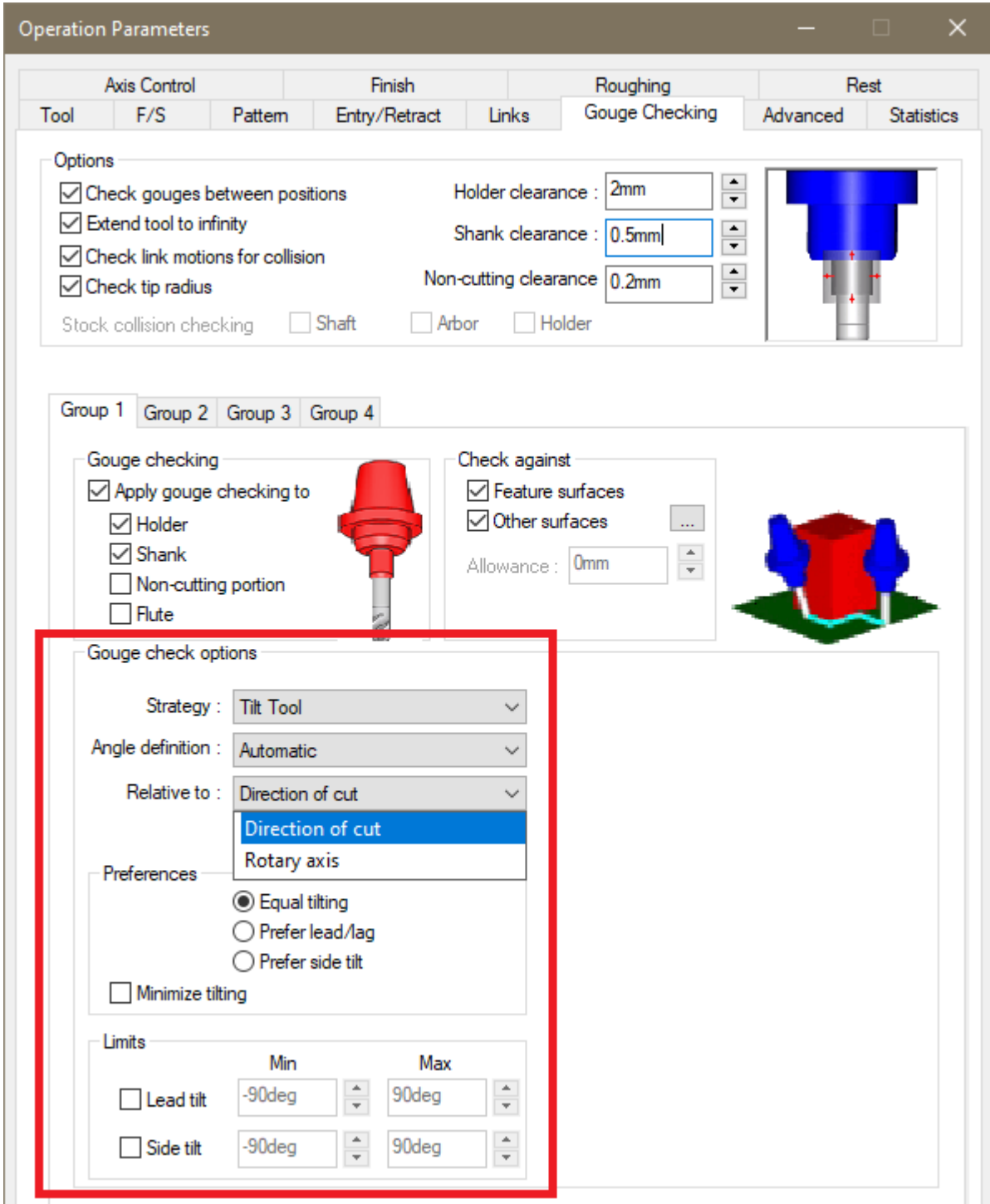

New 'Direction of cut' Option in Gouge Checking tab under Operation Parameters Dialog Box of Multiaxis Mill Operations



New - Interface to Define and Modify Multisurface features from Operation Parameters Dialog Box

Purpose:

To enable easier and faster user interaction with the CAMWorks application by allowing user to define/modify Multisurface features, Avoid features, Contain Areas and Avoid Areas from Operation Parameters dialog box interface itself

Implementation:



In previous versions of CAMWorks, when viewing/editing the parametric values and settings in the **Operation Parameters** dialog box for a 3 Axis Mill operation, if users wished to change/add the properties of the Multisurface feature associated with that operation, then it was a circuitous process. Users had to close **Operation Parameters** dialog box, navigate to the corresponding feature in the **Feature tree**, edit its properties, save the changes, and close the interface and then navigate back to the **Operation** tree and re-open the **Operation Parameters** dialog box by double-clicking on the specific operation. The case was similar for Avoid features, Avoid Areas and Contain Areas. As the geometry of the Multisurface features, Avoid Features, Contain Areas and Avoid Areas usually require frequent editing when programming a part or assembly, this process can prove to be a tad cumbersome.

From CAMWorks 2022 version onwards, this issue has been addressed in the form of a new tab named **Geometry** made available under the **Operation Parameters** dialog box for 3 Axis Mill operations. This tab allows users to directly view, add or modify the multisurface features, Avoid features, Avoid Areas and Contain Areas associated with the active 3 Axis Mill operations. Also, existing settings of **Automatic Contain Area** and **Avoid small profiles** previously available under the **Advanced** tab have been shifted to the **Geometry** tab.



Following are the newly introduced group boxes and command buttons within this tab:

'Features (Faces to cut)' Group Box

Use this list box and adjacent command buttons within this group box to define/edit/select the multisurface features to be machined by the current operation.





-  **Create button:** Use this command when you wish to add an additional multi surface feature to be machined by the current operation. Executing this command button will display the **New Multi surface Feature** dialog box. Any feature thus added will be listed in the list box.
-  **Edit button:** Use this command when you wish to edit the geometry of a multi surface feature listed within the list box. To edit a desired multi surface feature listed in the list box, select that multi surface feature and then execute this command button. Executing this command will display the **New Multi surface Feature** dialog box.
-  **Advanced button:** Executing this command displays the **Select Features** dialog box. Use this dialog box to select/deselect the multisurface features to be machined by the current operation.

'Avoid Features (Faces to avoid)' Group Box

This list box within this group box lists all the multi surface features that have been defined as Avoid features for the current Mill operation. You can define, edit, and select/deselect the Avoid features for the current operation using the **Create** , **Edit**  and **Advanced**  button adjacent to the list box.





'User defined contain area' Group Box

This list box within this group box lists all the Contain Areas defined for the current Mill operation.

You can define, edit, and delete the Contain Areas using the **Create** , **Edit**  and **Delete**  button adjacent to the list box. Use the **Properties** command  to view the properties of the selected Contain area.



'User defined contain area' Group Box

This list box within this group box lists all the Contain Areas defined for the current Mill operation. You can define, edit, and delete the Contain Areas using the **Create** , **Edit**  and **Delete**  button adjacent to the list box. Use the **Properties** command  to view the properties of the selected Contain area.

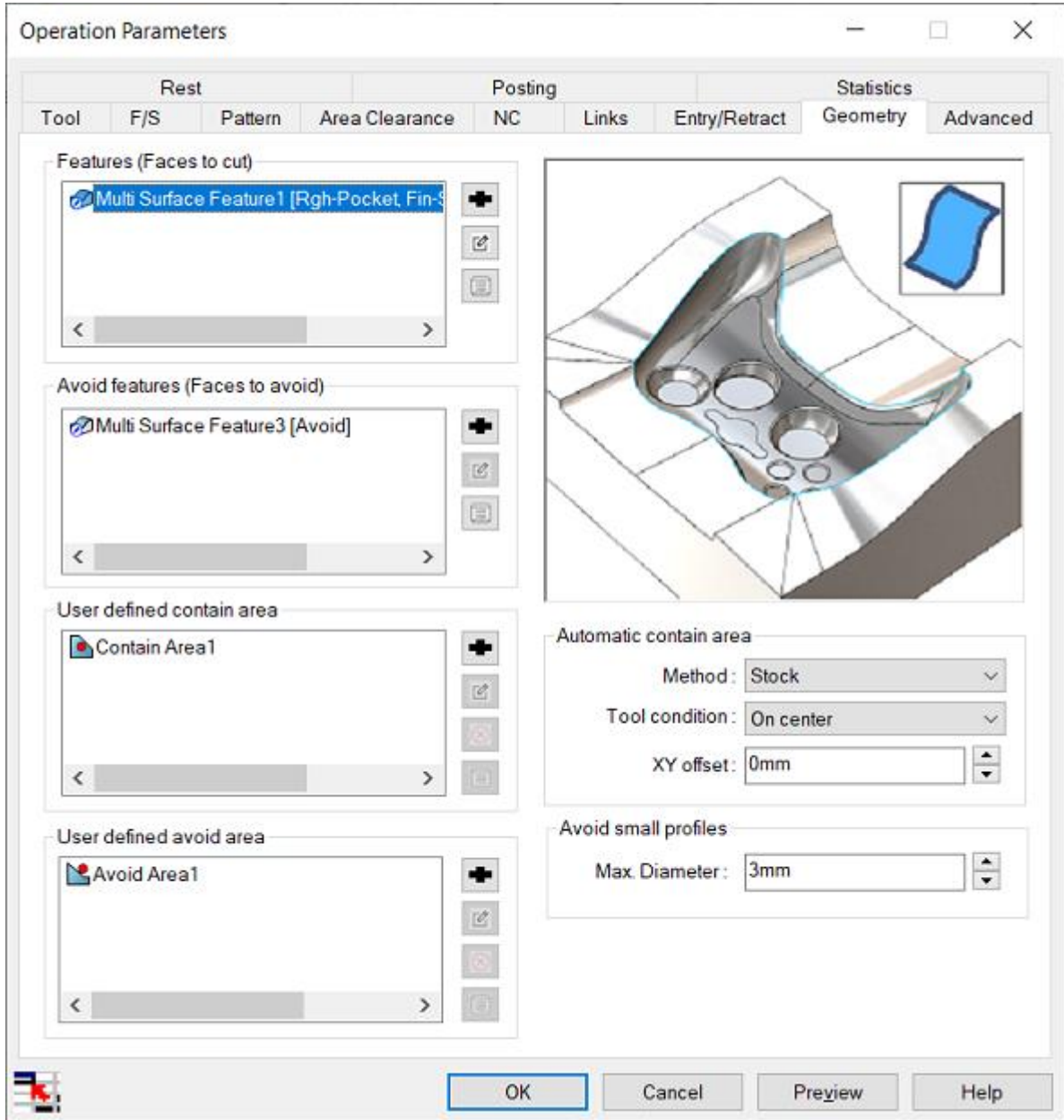

Geometry Tab in Operation Parameters Dialog Box of 3 Axis Mill Operations



Improved - Enhanced 'Machine to Mean' function for Contour Mill Operations to achieve Maximum Material Condition

Purpose:

Enhanced **Machine to Mean** function for Contour Mill operations generated for 2.5 Axis Mill features such that the feature for which the Contour Mill toolpath has been generated) achieves **Maximum Material Condition (MMC)**

Implementation:

How 'Machine to Mean' Worked in Previous Versions of CAMWorks

The **Machine to Mean** functionality in the **Run** tab of the **Tolerance Based Machining - Run** dialog box is applicable only for Mill operations generated for 2.5 Axis Mill features machined based on tolerance ranges specified for their dimensions.

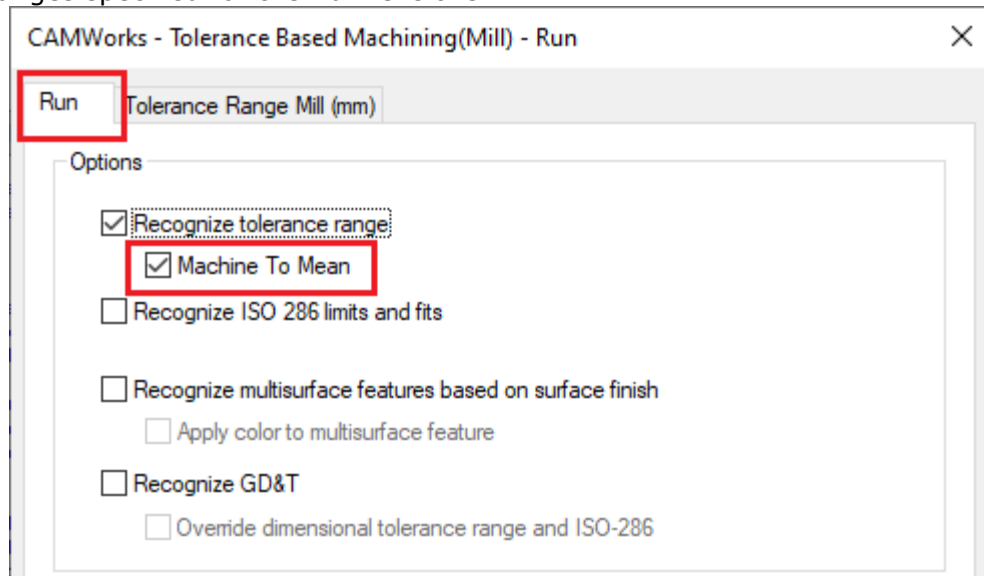

'Machine To Mean' Option in Run Tab

In previous versions of CAMWorks, this **Machine to Mean** functionality would not always achieve the **Maximum Material Condition (MMC)** for 2.5 Axis Mill features machined using a Contour Mill toolpath. This especially occurred for features with multiple dimensions and multiple tolerance ranges. CAMWorks would randomly choose the **Tolerance Mean** for one of the dimensions and then use it for machining to mean that specific Mill feature. The randomly chosen Tolerance Mean would not always guarantee that the **Maximum Material Condition (MMC)** was achieved. (MMC might be achieved with the tolerance mean computed for another dimension of the feature.)

Similarly, for Circular Pocket features and hole features, their positional tolerance rather than their dimensional tolerance was considered in some cases. This resulted in incorrect mean dimensions that either undercut or overcut that feature (due to wrong strategy being assigned in lieu of wrong the mean dimensions).

How 'Machine to Mean' will Work from CAMWorks 2022 Version Onwards

From **CAMWorks 2022** version onwards, when the **Machine to Mean** functionality is enabled, for Contour Mill operations, CAMWorks will internally calculate **Material Condition** achieved using the **Tolerance Mean** computed for each dimension of the Mill feature. CAMWorks will then compare which set of dimensions based on the different Tolerance Mean values achieves **Maximum Material Condition (MMC)**. The Tolerance Mean that enables **Maximum Material Condition (MMC)** will be used for machining to mean. This **Tolerance Mean** will be displayed in the **Allowance** field of the **Contour Mill** tab of the Contour Mill operation.

For circular pocket features and holes, for the **Machine to Mean** calculations, only Dimensional Tolerances given to the feature will be considered to derive the mean value for those features. Positional tolerances will not be considered.



Illustrative Example of 'Machine to Mean' function will work for Contour Mill Operation generated for a Rectangular Pocket Feature

For pocket features, the **Maximum Material Condition (MMC)** will be achieved when the dimensions of the pocket feature are at their smallest. Consider the below rectangular pocket feature with a length of 50 units (with an Upper Tolerance Limit of 0.4 units and a Lower Tolerance Limit of 0 units) and a width of 30 units (with an Upper Tolerance Limit of 0 units and a Lower Tolerance Limit of -0.5 units).



Illustrative Example of Pocket Feature that will be Machined to Mean

Machined to Mean Values based on Tolerance Mean of Length Dimension

For the length dimension of 50 units, the computed Tolerance Mean is -0.1. Based on this value, the machined to mean values for the Length and Width will be:

- Length = Actual Length - (Tolerance Mean *2)
 = 50 - (-0.1 *2)
 = **50.2**
- Width = Actual Width - (Tolerance Mean *2)
 = 30 - (-0.1 *2)
 = **30.2**

Machined to Mean Values based on Tolerance Mean of Width Dimension

For the Width dimension of 30 units, the computed Tolerance Mean is 0.13. Based on this value, the machined to mean values for the Length and Width will be:

- Length = Actual Length - (Tolerance Mean *2)
 = 50 - (0.13 *2)
 = **49.74**
- Width = Actual Width - (Tolerance Mean *2)
 = 30 - (0.13 *2)
 = **29.74**

Tolerance Mean Considered by CAMWorks

Observe that the Mean dimensions (49.74, 29.74) computed using the Tolerance Mean of the Width dimension results in smaller dimensions for the pocket feature compared to those derived using Tolerance Mean of the Length dimension (50.2, 30.2). These smaller dimensions are in sync with the goal of achieving the **Maximum Material Condition (MMC)**. Hence, CAMWorks will use the Tolerance Mean of 0.13 for machining the pocket feature. This value will be displayed in the **Allowance** field of the **Contour Mill** tab of the Contour Mill operation.

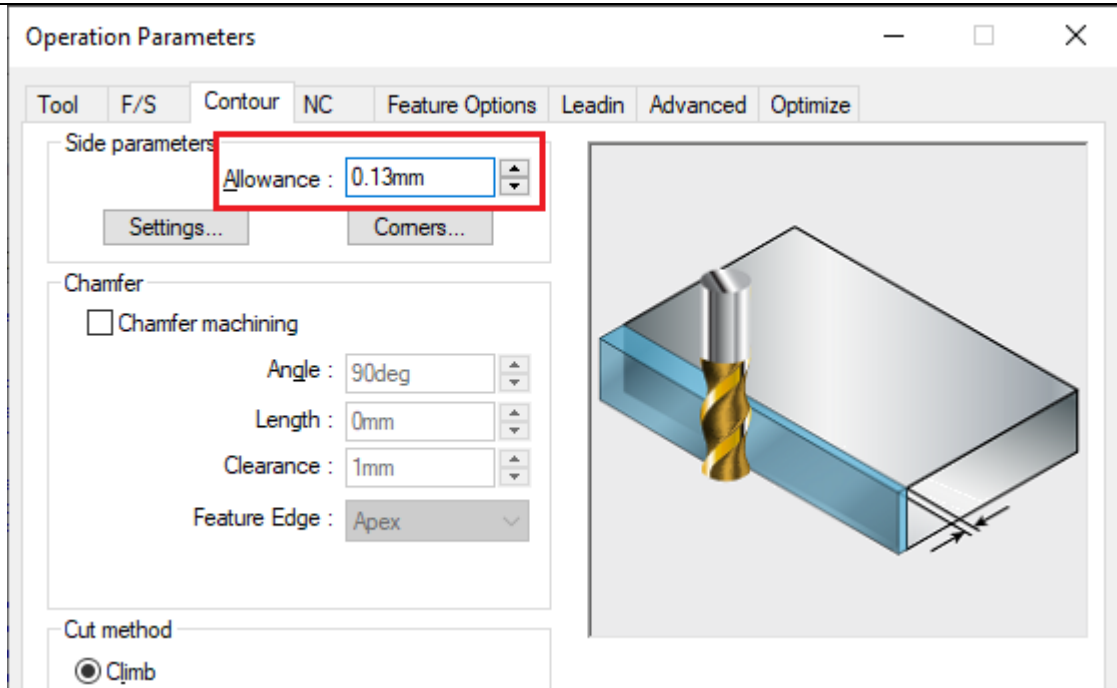

Allowance Field in Contour Mill Tab indicating the Tolerance Mean

Illustrative Example of 'Machine to Mean' function will work for Contour Mill Operation generated for a Hole or Circular Pocket Feature

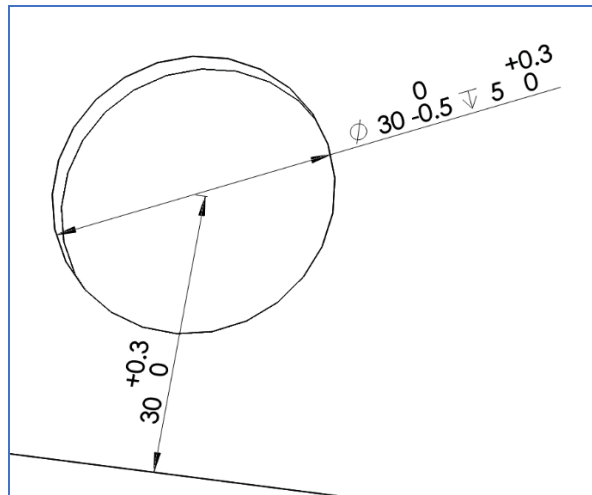

In the above example, the Tolerance Mean of -0.075 units computed based on the positional tolerance (0.3, 0) will not be considered for calculating Mean values of its dimensions. Instead, the Tolerance Mean of 0.125 units computed based on its diameter dimension's tolerance (0, -0.5) will be considered.



New - Option to Convert Rapid Moves to High Feed Moves for VoluMill Toolpaths

Purpose:

To provide an option whereby users can convert Rapid Moves into High Feed Moves for VoluMill toolpaths

Implementation:

For **Roughing** and **Area Clearance** operations with VoluMill pattern, when the **Convert rapid moves to high feed moves** option is checked, rapid moves will be converted to high feedrate moves. The feedrate applied for such moves is the **Non-cutting high feedrate**.

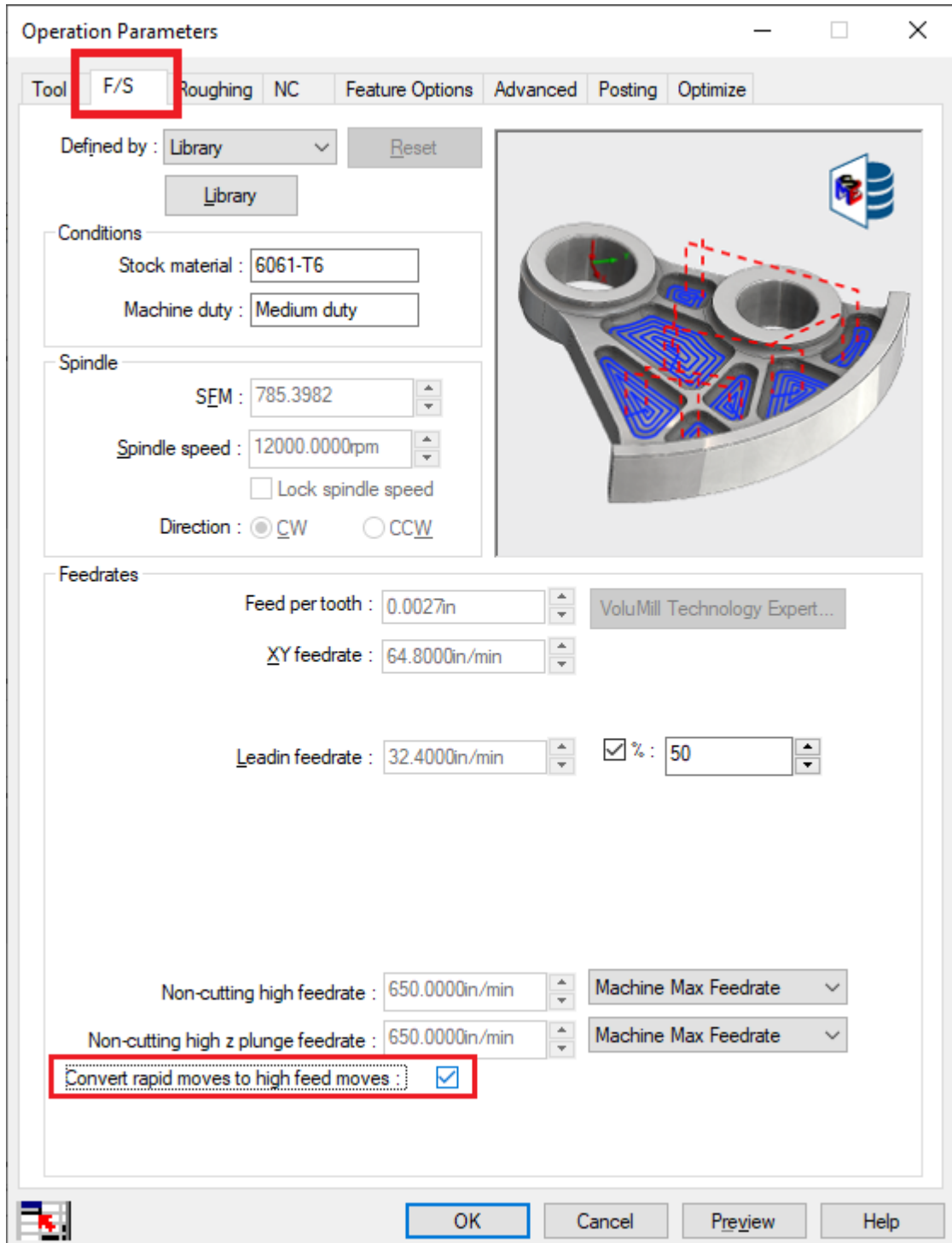

'Convert Rapid Moves to High Feed Moves' Option in F/S tab for VoluMill Operations



New - Option to Convert Arc Moves to Line Moves for VoluMill Toolpaths

Purpose:

To provide an option whereby VoluMill toolpath Arc Moves of 90 degrees or more can be split into several smaller lines moves (to enable correct generation of NC code by CNC Controller)

Implementation:

All toolpaths have moves comprising of lines and arcs. Occasionally, the CNC controller might not be able to correctly handle arc moves beyond 90 degrees. Under such circumstances, the arc moves must ideally be split into several small lines.

For VoluMill toolpaths, this functionality is available in the form of the *Line Moves Only* option. This new option **Line moves only** and its corresponding input value field (internally labelled **Deviation**) will be available in the **Options** group box of the **VoluMill Settings** dialog box.

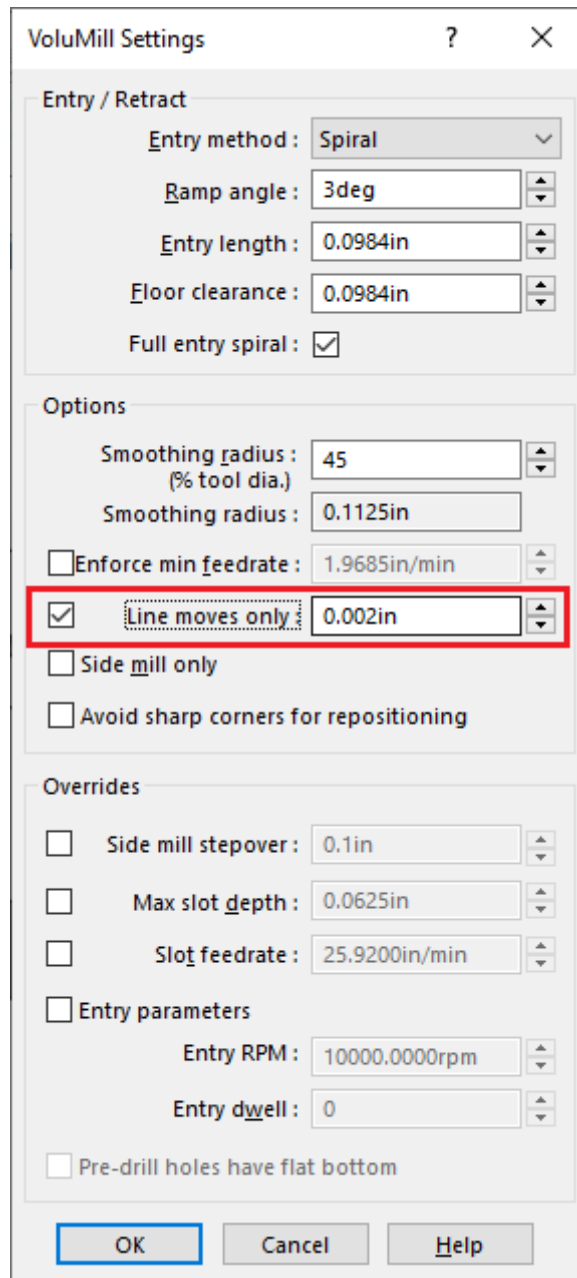

VoluMill Settings Dialog Box

By default, this checkbox is unchecked. When checked, the arc moves will be converted to line moves. Use the *Deviation* field adjacent to the *Line Moves Only* option to indicate for splitting the arcs into linear moves.



Improved - Intuitive Nomenclature for CNC Finish Parameters in NC tab of 2 Axis Mill Operations

Purpose:

To provide a more intuitive and simplified nomenclature for parameters associated with CNC Finishing under NC tab for Contour Mill Operations

Implementation:

In previous versions of CAMWorks, the nomenclature for parameters in the **CNC Finish Parameters** group box under **NC tab** for Contour Mill wasn't very intuitive.

From CAMWorks 2022 version onwards, the nomenclature of these parameters has been simplified and made more intuitive. The parameters have also been rearranged for better comprehension. The existing parameters of **Gouge Check** and **Sharp Corner** have been shifted into a new sub-group box named **Look ahead** within the **CNC Finish Parameters** group box.

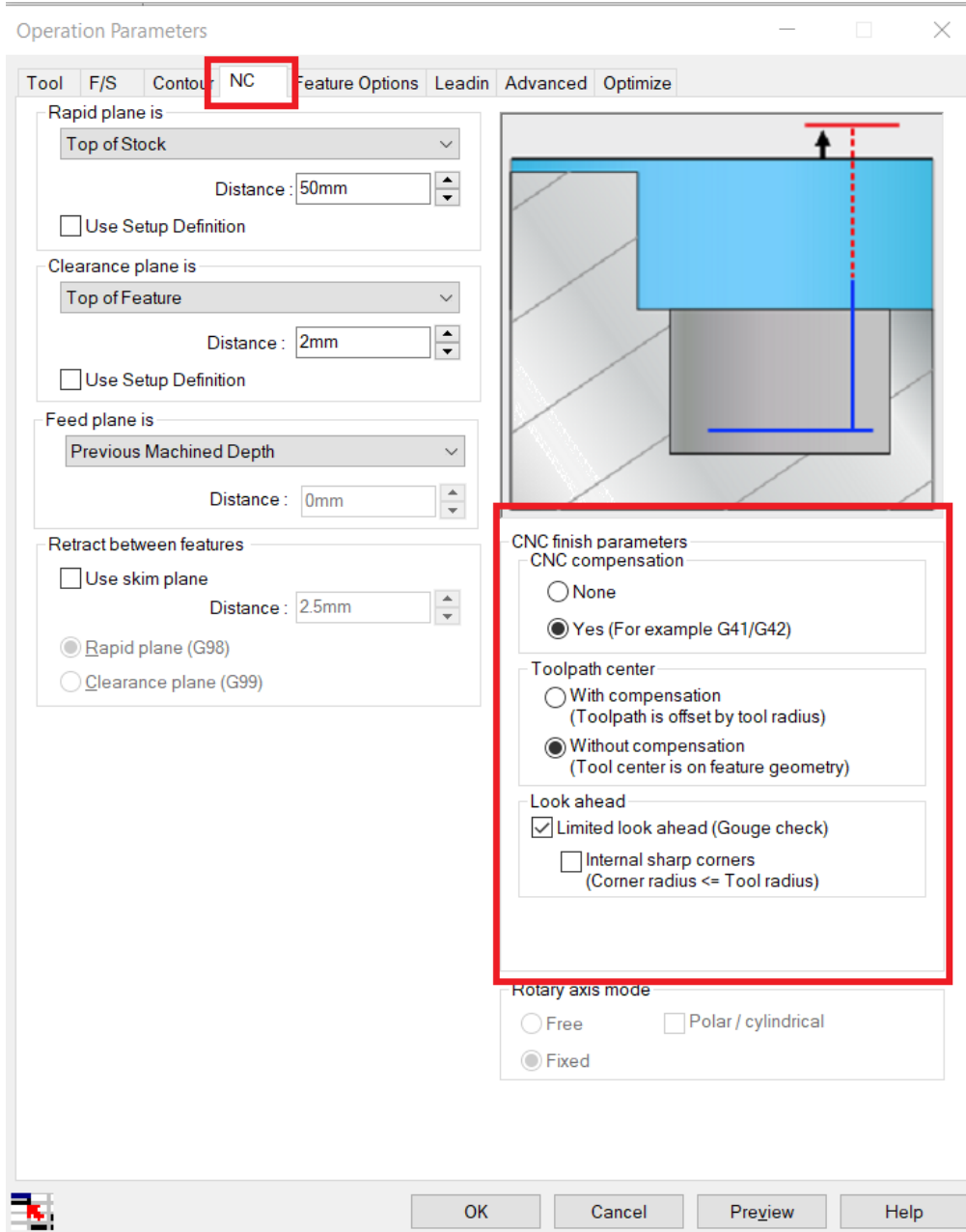

Simplified Nomenclature for Parameters within 'CNC Finish Parameters' group box under NC Tab



***Improved* - Leadin/Out Move Calculation And Display For Contour Mill Operations With CNC Toolpath Compensation**

Purpose:

To generate the leadin and leadout moves for Contour Mill toolpaths in such a manner that the XY start and end points will be at the compensated location. This will ensure that users will be able to visualize the start and end points when the CNC compensation option is set to Yes (With G41/42) and Toolpath center is set to Without compensation

Implementation:

In earlier versions of CAMWorks the XY leadin and leadout positions and move values differ depending on whether Toolpath Center is With or Without compensation. From CAMWorks 2022 onwards the calculation of uncompensated leadin/out moves has been enhanced to generate uncompensated leadin and leadout moves so that when the mill machine computes the compensated toolpath, that the actual toolpath motion on the mill machine better more accurately represents the compensated toolpath that CAMWorks generates. In addition to maintaining the same XY start and end positions, CAMWorks will automatically add the tool radius to any arc moves specified for leadins and leadouts. For example, if a 10mm diameter tool is being used with an arc leadin of 3mm then, the calculated leadin arc value will be 8mm. When the toolpath is compensated on the machine, the resulting motion will produce an arc move of 3mm. For other types of leadin/out moves, the length and angle of the leadin/leadout line segments are automatically adjusted such that the uncompensated toolpath will generate the desired compensated toolpath on the mill machine without additional user modifications to the leadin/out parameters This enhancement has been implemented to reduce confusion, errors and simplify the definition of the leadin/out parameters.

For all the legacy parts, contour mill toolpaths will need to be regenerated for these changes to take effect.



License

New - License Activation Method: Online Activation using Activation IDs

Purpose:

The **Online Activation** method (introduced from **CAMWorks 2022 SP0** version onwards) employs 'Activation IDs' that functions as software keys for activating the products and modules within the **CAMWorks** suite of application.

Implementation:

These Activation IDs for products in the CAMWorks suite are alphanumeric in nature and consist of 32 characters. When renewing/purchasing the CAMWorks subscription, you need to specify your license type (Nodelocked/Floating Network), the desired CAMWorks modules/products you wish to use and then pay the applicable license fees. HCL Technologies Ltd. (IP owners of the CAMWorks software application) will then provide you with one or more Activation IDs for activating the purchased products.

Once received, these Activation ID(s) must be input by you in the relevant user interface of the **CAMWorks License Manager** tool for license activation. These Activation ID(s) are then validated and verified online. If successfully verified, then the CAMWorks application (with specific products and modules paid for by you) will be activated.

Status of Previously Existing License Activation Method of 'License File Based Activation'

Online Activation method for license activation has been newly introduced in **CAMWorks 2022 SP0** version. The previously existing **License file based** method for license activation will continue to remain available within the **CAMWorks License Manager** tool. However, do note that the license file based method for license activation will gradually be phased out.

As of now, in the **CAMWorks 2022** version, you will have the option to choose either the **Online Activation** or **License file based** method of license activation when purchasing/renewing your **CAMWorks** subscription.

We recommend that you switch to the more convenient **Online Activation** method.

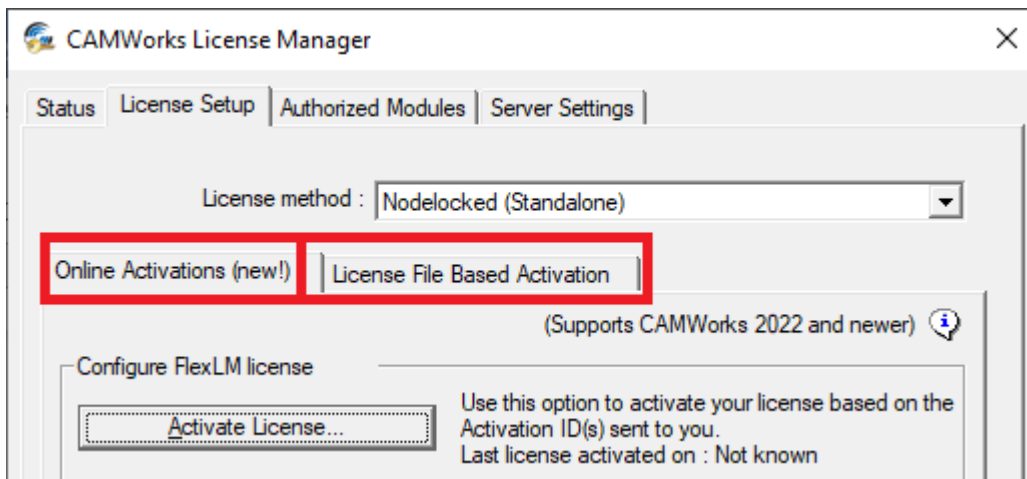

Nodelocked License: [Separate Tabs in License Setup Tab for Online Activation and License File Based Activation](#)

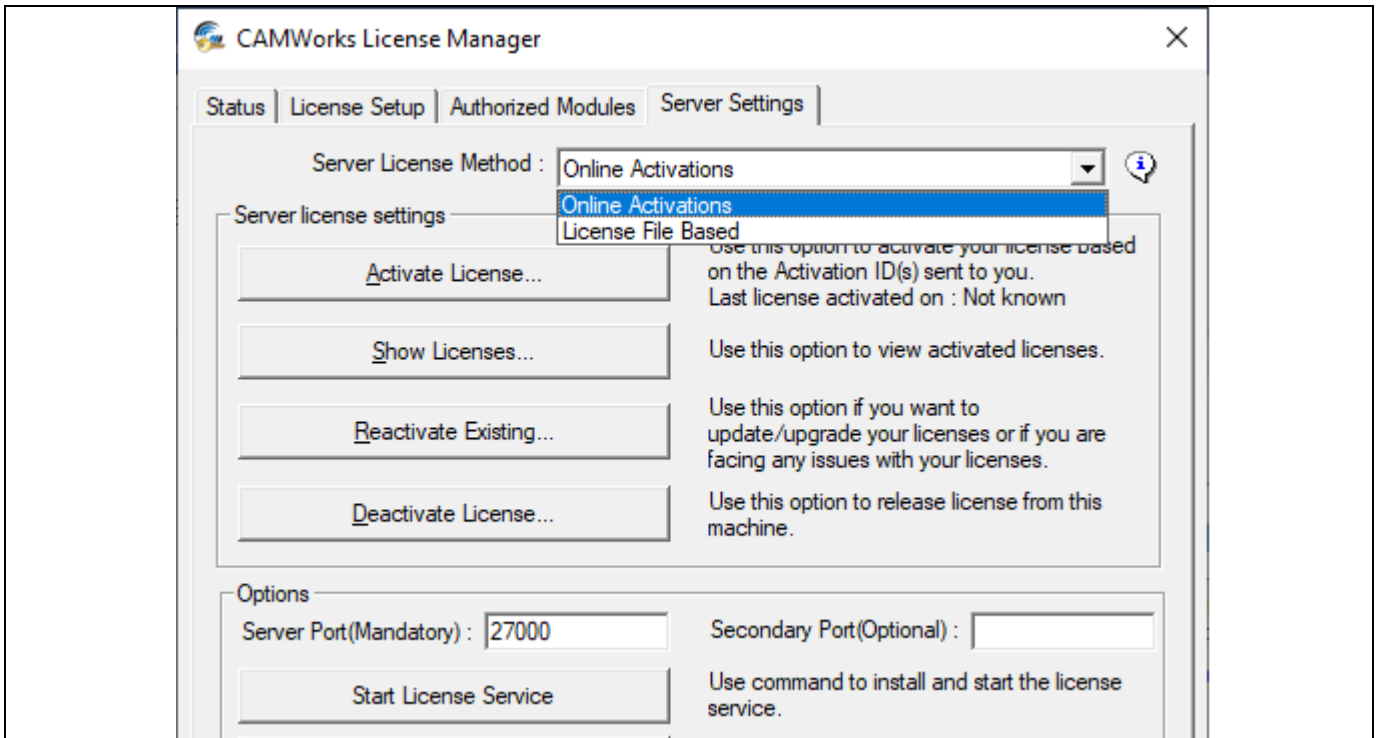

Floating Network Server License: Separate Options provided for License Activation in Server Settings Tab

Activation Options For ‘Online Activation’ Method of License Activation

Depending on whether you have or do not have access to the Internet on the 64-bit Windows system (on which the CAMWorks license will be activated), following two options will be available for Online Activation

Automatic Method:

In **Automatic** method of *Online license* activation, a live Internet connection is required for activating the license. You need to input the Activation IDs provided to you and then have them validated. Once successfully validated, the activated *CAMWorks* products will be displayed within the **CAMWorks Product Activation - Currently Activated Products** dialog box.

Manual Method:

This option is recommended only if you do not have a live internet connection. In this method of *Online License* activation, you need to create a license request file using the Activation IDs (Entitlement IDs) provided to you and then email it to register@camworks.com. As a response, you will receive a response file attachment via email. You need to load this response file to activate your CAMWorks products. Once successfully validated, the activated CAMWorks products will be displayed within the **CAMWorks - Currently Activated Products** dialog box.

Reactivating your License using Online Activation Method

If you wish to upgrade or renew your CAMWorks license, the **Online Activation** method provides separate **CAMWorks Product Reactivation** user interfaces within the *CAMWorks License Manager* tool to reactivate your license using your existing Activation IDs. (Both **Automatic** and **Manual** options of license reactivation are available.)



CAMWorks Product Reactivation
✕

Reactivate Your CAMWorks Product
Selected products listed below will be reactivated.

How would you like to reactivate?

Automatically over the Internet (Recommended)

Manually via E-Mail (Add all activation IDs and then click on activate)

Please select the product that need to be reactivated : Select all

	Product	Expiry Date	USP Date	Activation ID	Status
<input checked="" type="checkbox"/>	Commercial	Permanent	31-Oct-2022	2420-4345-38b5-43f5-a717-023a-3663-e514	Active
<input checked="" type="checkbox"/>	CAMWorks Milling Professional	Permanent	31-Oct-2022	2420-4345-38b5-43f5-a717-023a-3663-e514	Active
<input checked="" type="checkbox"/>	CAMWorks Solids P	Permanent	31-Oct-2022	2420-4345-38b5-43f5-a717-023a-3663-e514	Active
<input checked="" type="checkbox"/>	Commercial	Permanent	31-Oct-2022	2420-4345-38b5-43f5-a717-023a-3663-e514	Active

I have read the HCL Technologies [Privacy Policy](#) and agree to its terms and conditions.

Reactivate My Product(s) Close Help

User Interface for Reactivating your License via Online Activation Method

Advantages of ‘Online Activation’ Method of License Activation – Prompt Deactivation and Activation

In the previously used **License file based** method, users had to inform support about the intention to switch system, raise a new license request file from the new system, then wait for one business day to get the license file required for product activation. Consequently, shifting a *Nodelocked* or *Floating Network* installation from one system to another was a bit cumbersome. This issue is addressed with the *Automatic* option of *Online Activation*. To switch from one system to another, use the **CAMWorks Product Deactivation** UIs available within the *CAMWorks License Manager* tool to deactivate your products from the current system and then activate it on another system (using the **CAMWorks Product Activation** UIs). This process requires no intervention from CAMWorks Support or waiting for any email replies. (Both **Automatic** and **Manual** options of license deactivation are available.)

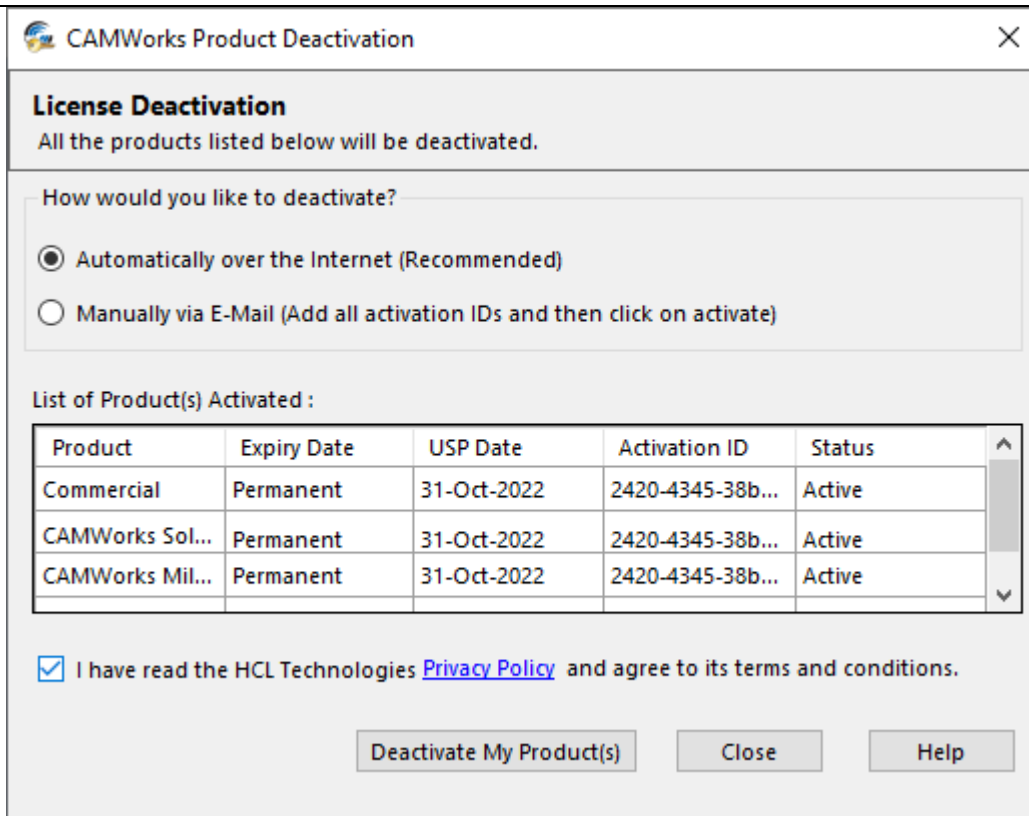

User Interface to Deactivate your CAMWorks License

License Activation on Clients of a Floating Network Installation

(After License Activation/Reactivation via Online Activation Method)

The process of license activation on Client machines (by inputting the **CAMWorks License Server** Host name and Port Number details in **License Setup** tab of the **CAMWorks License Manager** tool) remains identical to the License File Based method of license activation.

Steps to Activate Your CAMWorks Products using 'Automatic' Option of Online Activation

Refer the steps accompanied by user interface images on the next two pages for details on how to activate license using **Automatic** option of **Online Activation**.

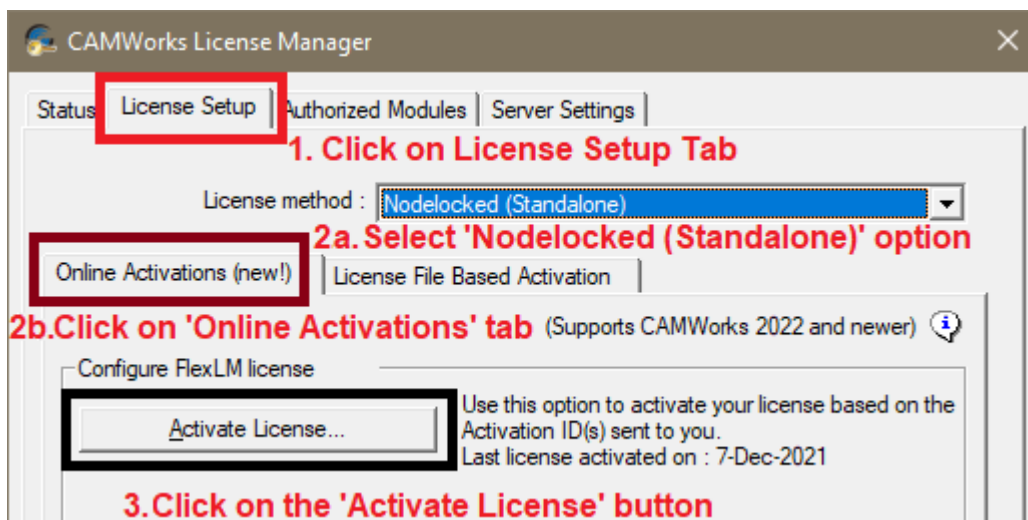

Steps 1-3: Click 'Activate License' Button in License Setup Tab for Nodelocked License

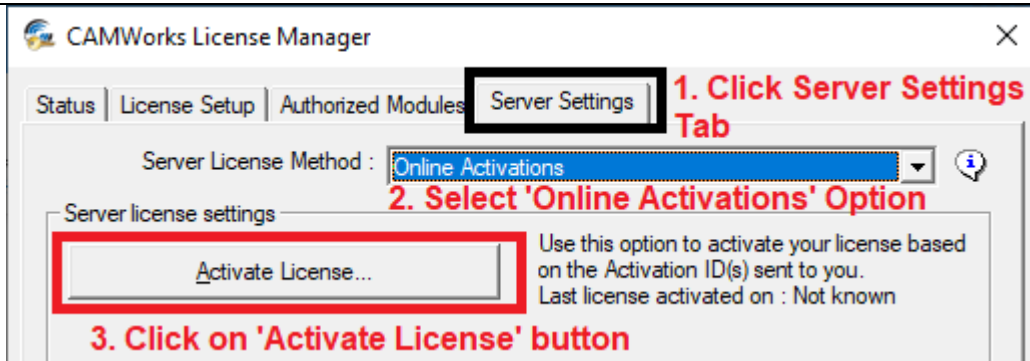

Steps 1-3: Click 'Activate License' Button in Server Settings Tab for Floating Network Server License

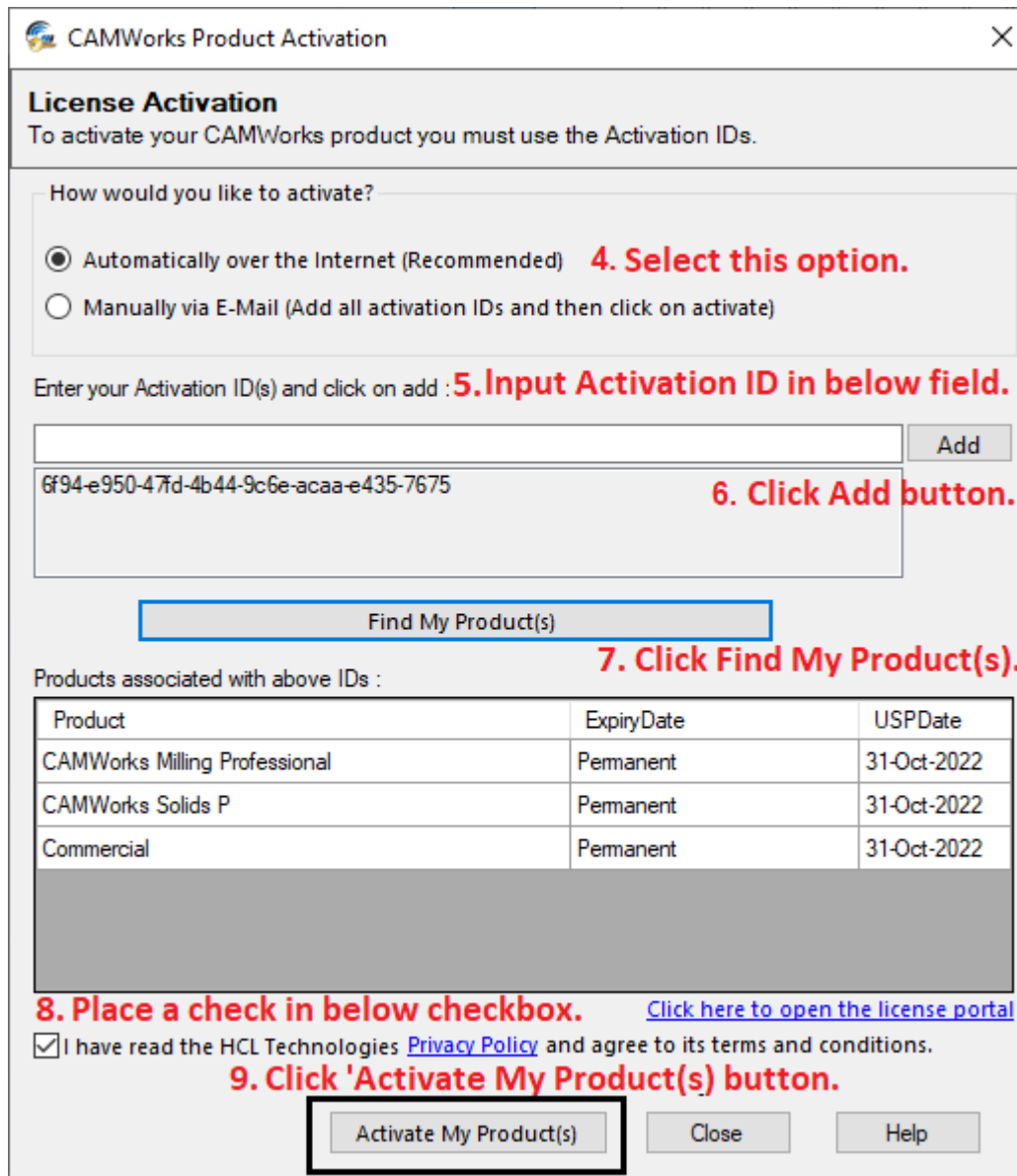

Step 4-9: In the next UI that is displayed, select 'Automatic' option, input Activation ID(s), Agree to Licensing Terms and click Activate My Products... Button.

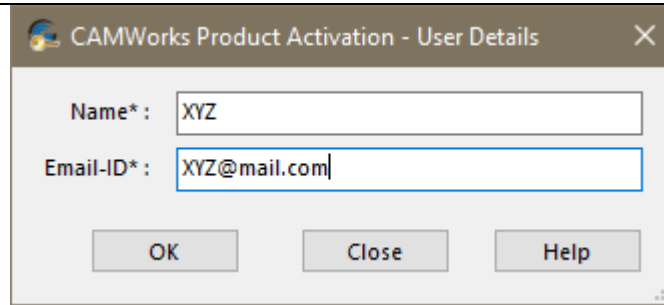

Step 10: In the next UI, input user details and click OK

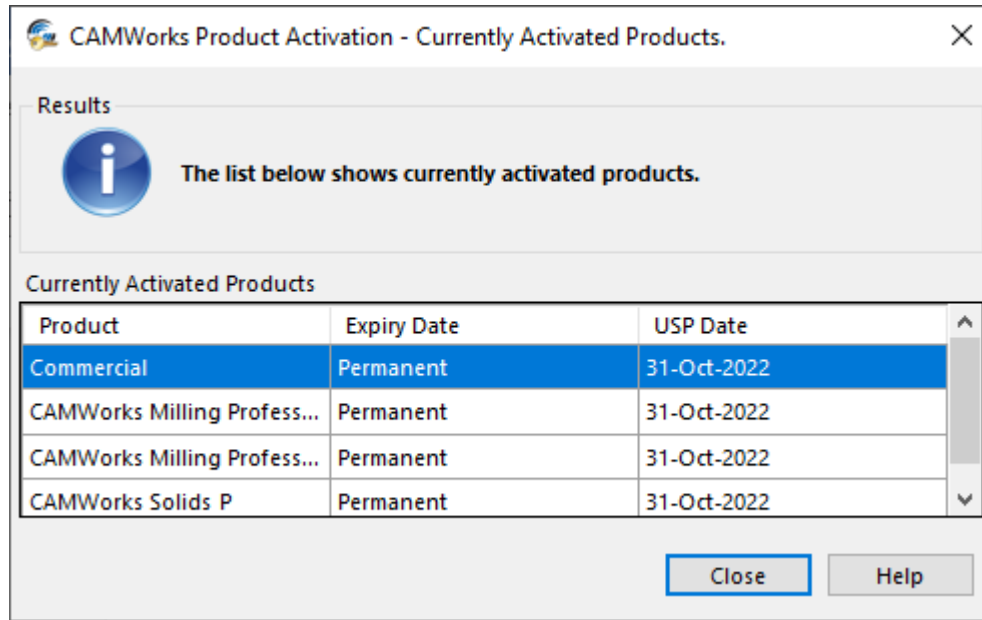

Step 11: In the next UI, the products successfully activated will be displayed. Click Close to exit.

Steps to Activate Your CAMWorks Products using 'Manual' Option of Online Activation

Refer the following steps accompanied by user interface images for details on how to activate license using **Manual** option of *Online Activation*.

Note:

Steps 1 to 3 for this option are identical to [Steps 1-3](#) for 'Automatic' Method.

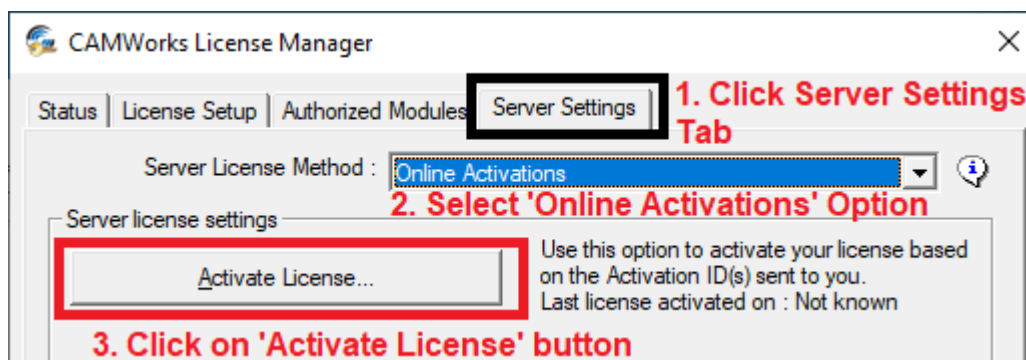

Steps 1-3: Click 'Activate License' Button in Server License Tab for Floating Network Server License



CAMWorks Product Activation

License Activation
To activate your CAMWorks product you must use the Activation IDs.

How would you like to activate?

Automatically over the Internet (Recommended) **4. Select this option.**

Manually via E-Mail (Add all activation IDs and then click on activate) **5. Input Activation ID in below field.**

Enter your Activation ID(s) and click on add :

6. Click 'Add' button.

7. Place a check in below checkbox.

I have read the HCL Technologies [Privacy Policy](#) and agree to its terms and conditions.

8. Click 'Activate My Product(s)' button.

Step 4-8: In the next UI that is displayed, select 'Manual' option, input Activation ID(s), Agree to Licensing Terms and click 'Activate My Products...' Button

CAMWorks Product Activation

1) Activation ID(s) which needs to be activated or deactivated

2) Press save to create a request file **9. Input User Details below.**

Name* :

Email-ID* :

10. Click Save to generate Request file. Email Request file to HCL.

3) Email the request to the following address to get a response file : **Register@camworks.com** OR Upload File on self service portal. (Login is required)

[Click here to open portal in a web browser](#)

4) Press open to load the response file **11. Download the response file you receive.**

12. Click Open to select and activate the Response file.

If you have received the response file, load it by clicking the Open button and then proceed with the below option. To discontinue, click Close. You can rerun the Wizard later.

13. Click 'Activate My Product(s)' button.

Step 9-13: In the next UI that is displayed, input user details, save and email the request file. Use the 'Open' button to browse and select the response file you receive. Activate this file by clicking the 'Activate My Products...' button.