

# What's New in



HCL Technologies Ltd. makes no warranties, either expressed or implied with respect to this document. HCL reserves the right to revise and improve products as it sees fit, and to revise the specifications and information contained herein without prior notice. Due to continuing product development, specifications and capabilities described in this document are subject to change without notice.

**Copyright © 2024-2025 HCL Technologies Ltd. All Rights Reserved.**  
**November 2025**



# Table of Contents

(Click a link below or use the bookmarks on the left.)

<b>What’s New in CAMWorks 2025 SP5</b>	<b>3</b>
Supported Platforms	3
Resolved CPRs Document	3
<b>What’s New in CAMWorks 2025 SP4</b>	<b>4</b>
Supported Platforms	4
Resolved CPRs Document	4
<b>What’s New in CAMWorks 2025 SP3</b>	<b>5</b>
Supported Platforms	5
Resolved CPRs Document	5
<b>What’s New in CAMWorks 2025 SP2</b>	<b>6</b>
Supported Platforms	6
Resolved CPRs Document	6
<b>What’s New in CAMWorks 2025 SP1</b>	<b>7</b>
Supported Platforms	7
Resolved CPRs Document	7
<b>What’s New in CAMWorks 2025 SP0</b>	<b>8</b>
Supported Platforms	8
Resolved CPRs Document	8
<b>General .....</b>	<b>9</b>
Compatibility of CAMWorks with SOLIDWORKS Apps Connected to 3DEXPERIENCE Platform	9
CAMWorks & CAMWorks Utilities as a Partner Gold Add-in and Partner Solution Add-in within SOLIDWORKS Add-Ins	10
Option to Reset All Machine Data in Simulation Machine	11
Option to view Simulation Machine Components During Toolpath Simulation	12
Collision Detection Options for Machine Components During Toolpath Simulation	14
<b>Mill.....</b>	<b>16</b>
Chamfer Machining using Ball Nose, Hog Nose, and Lollipop Tools	16
<b>Turn/Mill-Turn .....</b>	<b>18</b>
Options for Automatic Feature Recognition of Turn Features	18
Collets as Work Holding Device for Turn and Mill-Turn Machines	20
Support for Bar Break Chamfering of the Stock in Turn Toolpaths	23
Turret and Spindle Based Views for CAMWorks Sync Manager	26
Orientation for Mill Tools in Mill-Turn Tool Cribs	28



# What's New in CAMWorks 2025 SP5

## Supported Platforms

Supported Platforms for 64-bit	
<b>Solid Modeler:</b>	The 64-bit version of: <ul style="list-style-type: none"> <li>- SOLIDWORKS 2026</li> <li>- SOLIDWORKS 2025</li> <li>- SOLIDWORKS 2024</li> <li>- CAMWorks Solids 2026</li> <li>- CAMWorks Solids 2025</li> <li>- CAMWorks Solids 2024</li> <li>- <b>3D</b>experience SOLIDWORKS R2026x</li> <li>- <b>3D</b>experience SOLIDWORKS R2025x</li> </ul>
<b>Operating System:</b>	64-bit version of: <ul style="list-style-type: none"> <li>- Windows 11</li> <li>- Windows 10</li> </ul> <p style="text-align: right;">[*Home Editions are not supported]</p> <p><b>Note:</b> CAMWorks 2025 is supported only on 64-bit Operating systems.</p>

## Resolved CPRs Document

<b>Purpose of Document:</b>	The Resolved CPR ( <i>CAMWorks Problem Report</i> ) document has been updated to report the software errors that have been resolved in the current Service Pack (SP5).
<b>Path to Document:</b>	To view the document, select: <i>C:\Program Files\CAMWorks2025x64\CAMWorks_VC143\Lang\English\CW2025BuildInfo.pdf</i>



# What's New in CAMWorks 2025 SP4

## Supported Platforms

Supported Platforms for 64-bit	
<b>Solid Modeler:</b>	The 64-bit version of: <ul style="list-style-type: none"> <li>- SOLIDWORKS 2025</li> <li>- SOLIDWORKS 2024</li> <li>- CAMWorks Solids 2025</li> <li>- CAMWorks Solids 2024</li> <li>- <b>3D</b>experience SOLIDWORKS R2025x</li> </ul>
<b>Operating System:</b>	64-bit version of: <ul style="list-style-type: none"> <li>- Windows 11</li> <li>- Windows 10</li> </ul> <p style="text-align: right;">[*Home Editions are not supported]</p> <p><b>Note:</b> CAMWorks 2025 is supported only on 64-bit Operating systems.</p>

## Resolved CPRs Document

<b>Purpose of Document:</b>	The Resolved CPR ( <i>CAMWorks Problem Report</i> ) document has been updated to report the software errors that have been resolved in the current Service Pack (SP4).
<b>Path to Document:</b>	To view the document, select: <i>C:\Program Files\CAMWorks2025x64\CAMWorks_VC143\Lang\English\CW2025BuildInfo.pdf</i>



# What's New in CAMWorks 2025 SP3

## Supported Platforms

Supported Platforms for 64-bit	
<b>Solid Modeler:</b>	The 64-bit version of: <ul style="list-style-type: none"> <li>- SOLIDWORKS 2025</li> <li>- SOLIDWORKS 2024</li> <li>- CAMWorks Solids 2025</li> <li>- CAMWorks Solids 2024</li> <li>- <b>3D</b>experience SOLIDWORKS R2025x</li> </ul>
<b>Operating System:</b>	64-bit version of: <ul style="list-style-type: none"> <li>- Windows 11</li> <li>- Windows 10</li> </ul> <p style="text-align: right;">[*Home Editions are not supported]</p> <p><b>Note:</b> CAMWorks 2025 is supported only on 64-bit Operating systems.</p>

## Resolved CPRs Document

<b>Purpose of Document:</b>	The Resolved CPR ( <i>CAMWorks Problem Report</i> ) document has been updated to report the software errors that have been resolved in the current Service Pack (SP3).
<b>Path to Document:</b>	To view the document, select: C:\Program Files\CAMWorks2025x64\CAMWorks_VC143\Lang\English\CW2025BuildInfo.pdf



# What's New in CAMWorks 2025 SP2

## Supported Platforms

Supported Platforms for 64-bit	
<b>Solid Modeler:</b>	The 64-bit version of: <ul style="list-style-type: none"> <li>- SOLIDWORKS 2025</li> <li>- SOLIDWORKS 2024</li> <li>- CAMWorks Solids 2025</li> <li>- CAMWorks Solids 2024</li> <li>- <b>3D</b>experience SOLIDWORKS R2025x</li> </ul>
<b>Operating System:</b>	64-bit version of: <ul style="list-style-type: none"> <li>- Windows 11</li> <li>- Windows 10</li> </ul> <p style="text-align: right;">[*Home Editions are not supported]</p> <p><b>Note:</b> CAMWorks 2025 is supported only on 64-bit Operating systems.</p>

## Resolved CPRs Document

<b>Purpose of Document:</b>	The Resolved CPR ( <i>CAMWorks Problem Report</i> ) document has been updated to report the software errors that have been resolved in the current Service Pack (SP2).
<b>Path to Document:</b>	To view the document, select: C:\Program Files\CAMWorks2025x64\CAMWorks_VC143\Lang\English\CW2025BuildInfo.pdf



# What's New in CAMWorks 2025 SP1

## Supported Platforms

Supported Platforms for 64-bit	
<b>Solid Modeler:</b>	The 64-bit version of: <ul style="list-style-type: none"> <li>- SOLIDWORKS 2025</li> <li>- SOLIDWORKS 2024</li> <li>- CAMWorks Solids 2025</li> <li>- CAMWorks Solids 2024</li> <li>- <b>3D</b>experience SOLIDWORKS R2025x</li> </ul>
<b>Operating System:</b>	64-bit version of: <ul style="list-style-type: none"> <li>- Windows 11</li> <li>- Windows 10</li> </ul> <p style="text-align: right;">[*Home Editions are not supported]</p> <p><b>Note:</b> CAMWorks 2025 is supported only on 64-bit Operating systems.</p>

## Resolved CPRs Document

<b>Purpose of Document:</b>	The Resolved CPR ( <i>CAMWorks Problem Report</i> ) document has been updated to report the software errors that have been resolved in the current Service Pack (SP1).
<b>Path to Document:</b>	To view the document, select: C:\Program Files\CAMWorks2025x64\CAMWorks_VC143\Lang\English\CW2025BuildInfo.pdf



# What's New in CAMWorks 2025 SP0

## Supported Platforms

Supported Platforms for 64-bit	
<b>Solid Modeler:</b>	The 64-bit version of: <ul style="list-style-type: none"> <li>- SOLIDWORKS 2025</li> <li>- SOLIDWORKS 2024</li> <li>- CAMWorks Solids 2025</li> <li>- CAMWorks Solids 2024</li> <li>- <b>3D</b>experience SOLIDWORKS R2025x</li> </ul>
<b>Operating System:</b>	64-bit version of: <ul style="list-style-type: none"> <li>- Windows 11</li> <li>- Windows 10</li> </ul> <p style="text-align: right;">[*Home Editions are not supported]</p> <p><b>Note:</b> CAMWorks 2025 is supported only on 64-bit Operating systems.</p>

## Resolved CPRs Document

<b>Purpose of Document:</b>	The Resolved CPR ( <i>CAMWorks Problem Report</i> ) document has been updated to report the software errors that have been resolved in the current Service Pack (SP0).
<b>Path to Document:</b>	To view the document, select: C:\Program Files\CAMWorks2025x64\CAMWorks_VC143\Lang\English\CW2025BuildInfo.pdf



---

## General

### Compatibility of CAMWorks with SOLIDWORKS Apps Connected to 3DEXPERIENCE Platform

**Partnership with SOLIDWORKS:**

HCL, a member of the SOLIDWORKS Partner Program, has been officially authorized by Dassault Systèmes to develop, support, and promote add-ins for all SOLIDWORKS applications working with the cloud-based 3DEXPERIENCE platform (3DEXPERIENCE SOLIDWORKS, SOLIDWORKS with Cloud Services, and SOLIDWORKS 3D CAD with Collaborative Designer for SOLIDWORKS).

**Implementation:**

CAMWorks is seamlessly compatible with SOLIDWORKS with Cloud Services, a bundle including the industry-leading SOLIDWORKS 3D CAD application and Collaborative Designer for SOLIDWORKS which connects it to the 3DEXPERIENCE platform, a unified cloud-based product development environment.

CAMWorks functions works in the same way as with SOLIDWORKS desktop application with one major enhancement: CAMWorks helps customers further harness the power of data management and cross-discipline collaboration in the cloud, streamlining your product development processes. CAMWorks 2025 and later versions can be launched and run as Add-ins within the 3DEXPERIENCE SOLIDWORKS application.



**CAMWorks & CAMWorks Utilities as a Partner Gold Add-in and Partner Solution Add-in within SOLIDWORKS Add-Ins**

**Purpose:**

To ensure that the *CAMWorks* application and *CAMWorks Utilities* are listed under the *Partner Gold Add-ins* and *Partner Solution Add-ins* categories respectively within the *Add-ins* dialog box of the SOLIDWORKS application

**Implementation:**

The *CAMWorks* application and *CAMWorks Utilities* run as an Add-In within the *SOLIDWORKS/CAMWorks Solids* application. In previous versions of *CAMWorks*, the option to select *CAMWorks* and *CAMWorks Utilities* as an add-in was available under the *Other Add-ins* category within the *Add-Ins* dialog box of the *SOLIDWORKS* application.

*CAMWorks 2025* version onwards, *CAMWorks* will be listed under the *Partner Gold Add-ins* category and *CAMWorks Utilities* will be listed under the *Partner Solution Add-ins* category of *Add-Ins* dialog box.

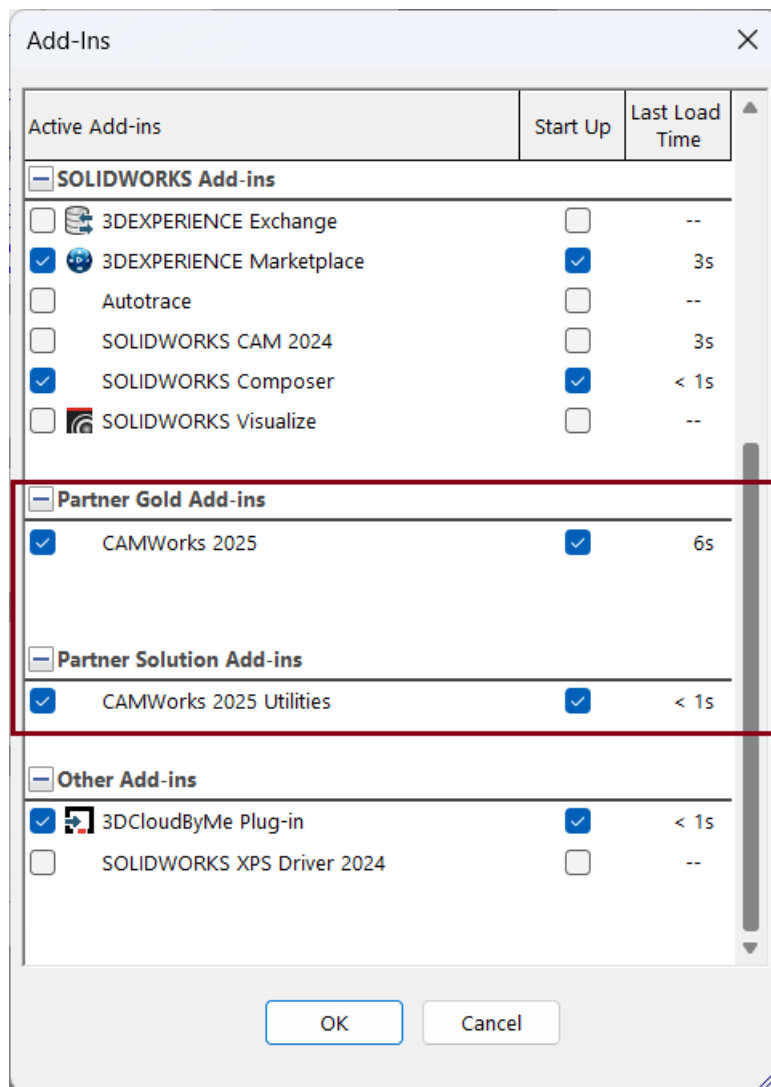

**CAMWorks 2025 and CAMWorks 2025 Utilities add-ins available under Partner Gold Add-ins and Partner Solution Add-ins Categories of Add-ins Dialog Box**



**New - Option to Reset All Machine Data in Simulation Machine**

**Purpose:**

Option to allow users to reset the data associated with the selected Simulation Machine modifications

**Implementation:**

In previous versions of *CAMWorks* there was no option to reset the customized Simulation Machine data in the *Machine Definition* dialog box.

From *CAMWorks 2025* version onwards, a new **Reset All Machine Data** button has been provided in the *Machine Definition* dialog box. This button will always be active. When this button is clicked, all the modifications done with the components of the selected machines are reset to the original state and they are displayed in the graphics area.

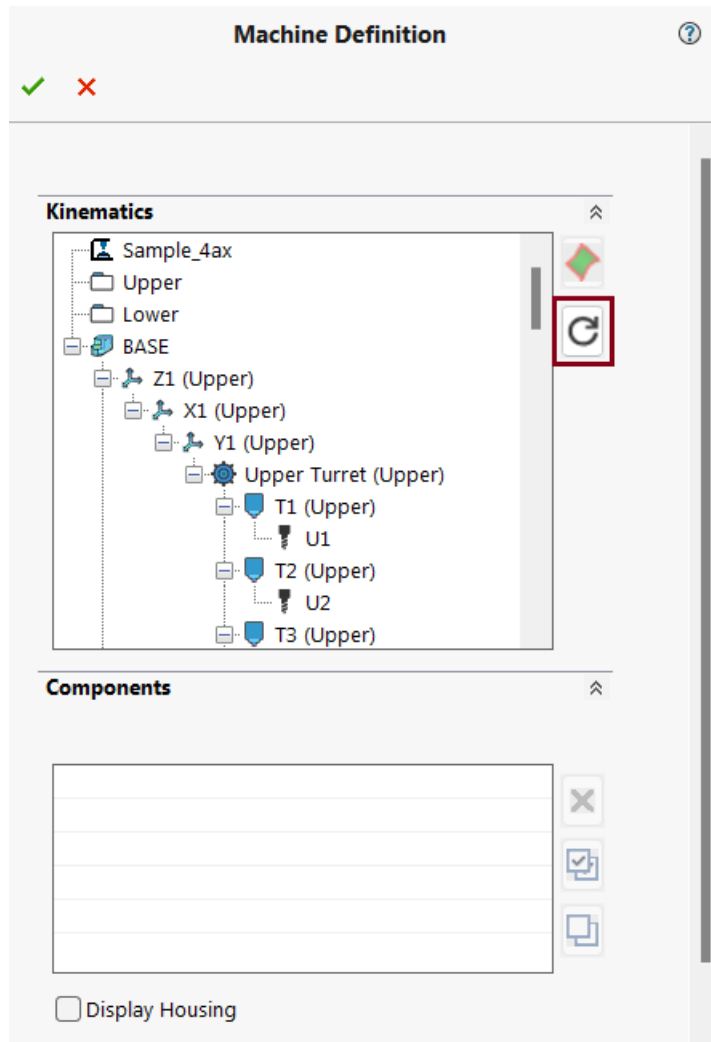

**'Reset All Machine Data' button in Machine Definition dialog box**



**New - Option to view Simulation Machine Components During Toolpath Simulation**

**Purpose:**

To provide option to view Simulation Machine components during toolpath simulation

**Implementation:**

The **Simulation Machine** dropdown list under **Machine** tab of the **Machine** dialog box allows you to select the desired Virtual Machine to be simulated i.e. *Simulation Machine*. From CAMWorks 2025 onwards, the **Display Components** toolbar will be displayed in the graphics area during toolpath simulation. Use the commands available within the *Display Components* toolbar to optionally view various machine components comprising the active Simulation Machine during toolpath simulation.

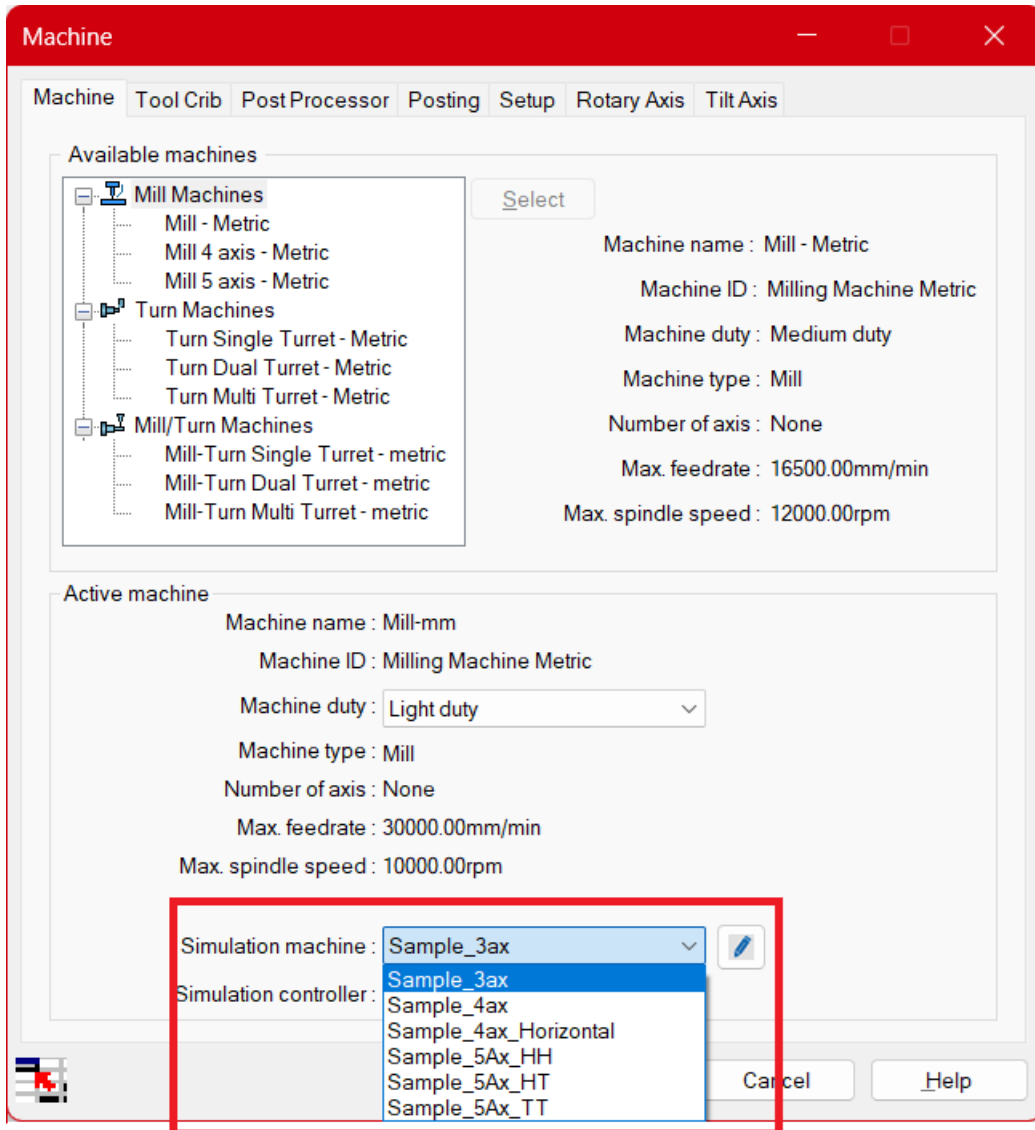

**Simulation Machine Dropdown list under Machine tab of Machine Dialog Box**

**Display Component toolbar Commands enabled During Toolpath Simulation**

The following command buttons and options of the **Display Components** toolbar will be enabled during the Toolpath Simulation process:

- Display Machine: (Use this toggle button to enable/disable the display of machine components of the Simulation Machine in the graphics area.)
- Tool & Tool Holder Display: (Use this button to change the display of the machining tools and holders in the graphics area.)



# What's New in CAMWorks 2025 SP0

- All Tools: (Available in Turn and Mill-Turn mode only; use this checkbox option to enable/disable the display of tools loaded on the turret in the graphics area.)

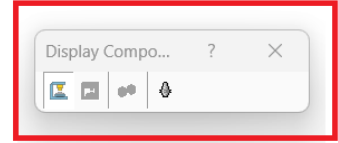
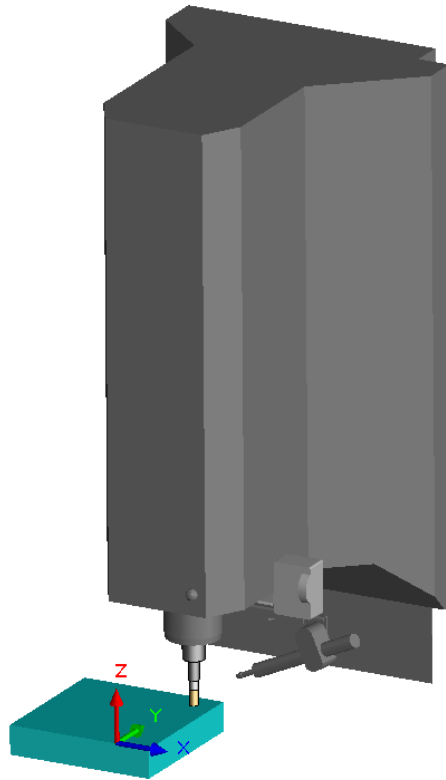
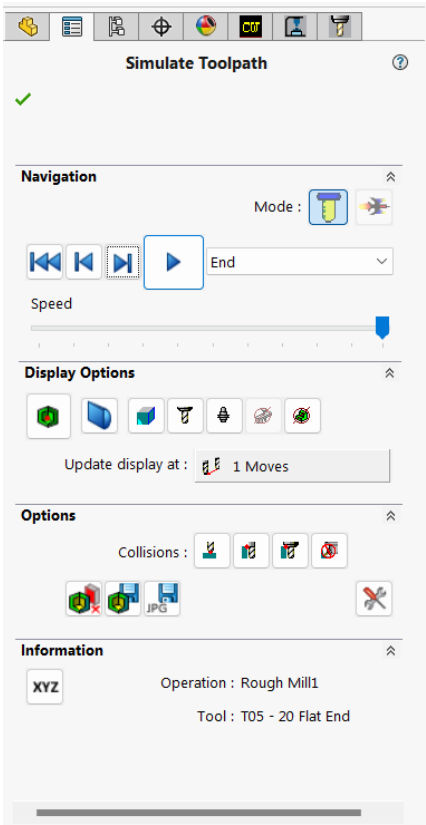

Sample Toolpath Simulation when Simulation Machine is a Mill Machine

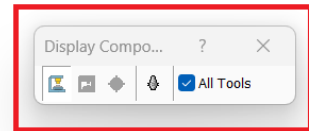
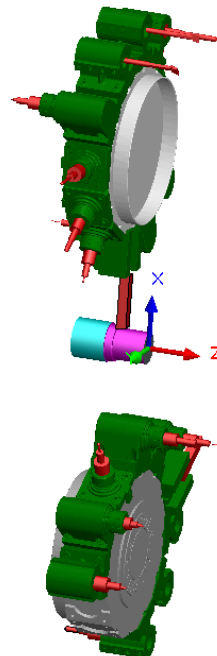
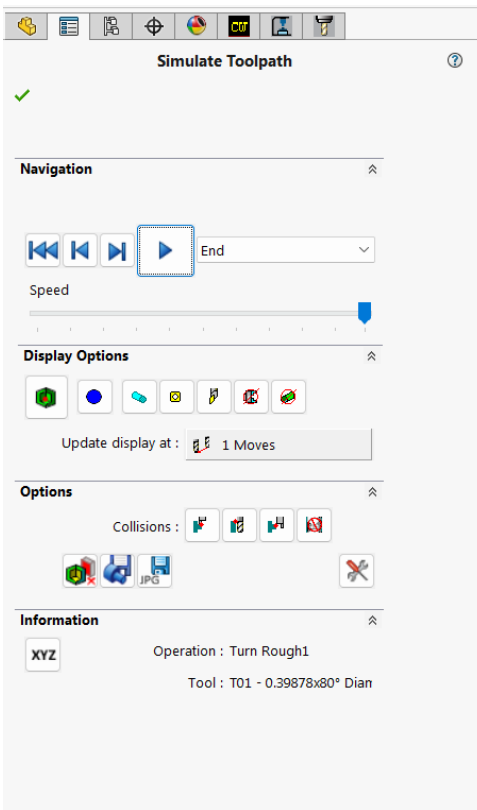

Sample Toolpath Simulation when Simulation Machine is a Turn Machine



**New - Collision Detection Options for Machine Components During Toolpath Simulation**

**Purpose:**

To provide collision detection options for Simulation Machine components displayed during toolpath simulation

**Implementation:**

From CAMWorks 2025 onwards, the commands available within the *Display Components* toolbar can be used to optionally view various machine components comprising the active Simulation Machine during toolpath simulation.

In the *Simulate Toolpath* dialog box, within its **Options** group box, a new set of buttons for collision detection for Machine Components has been introduced.

**Collision Detection Buttons for Machine Components**

The following collision detection buttons have been introduced:

Collision Detection Button for Machine Components in Mill Mode	Collision Detection Button for Machine Components in Turn Mode	Behavior of Collision Detection Button when Active
Ignore collision	Ignore Collision	The simulation ignores all collisions that occur between tool/holder and any machine components
Pause on collision	Pause on collision	The simulation pauses and displays a message when a collision occurs between tool/holder and any machine component.

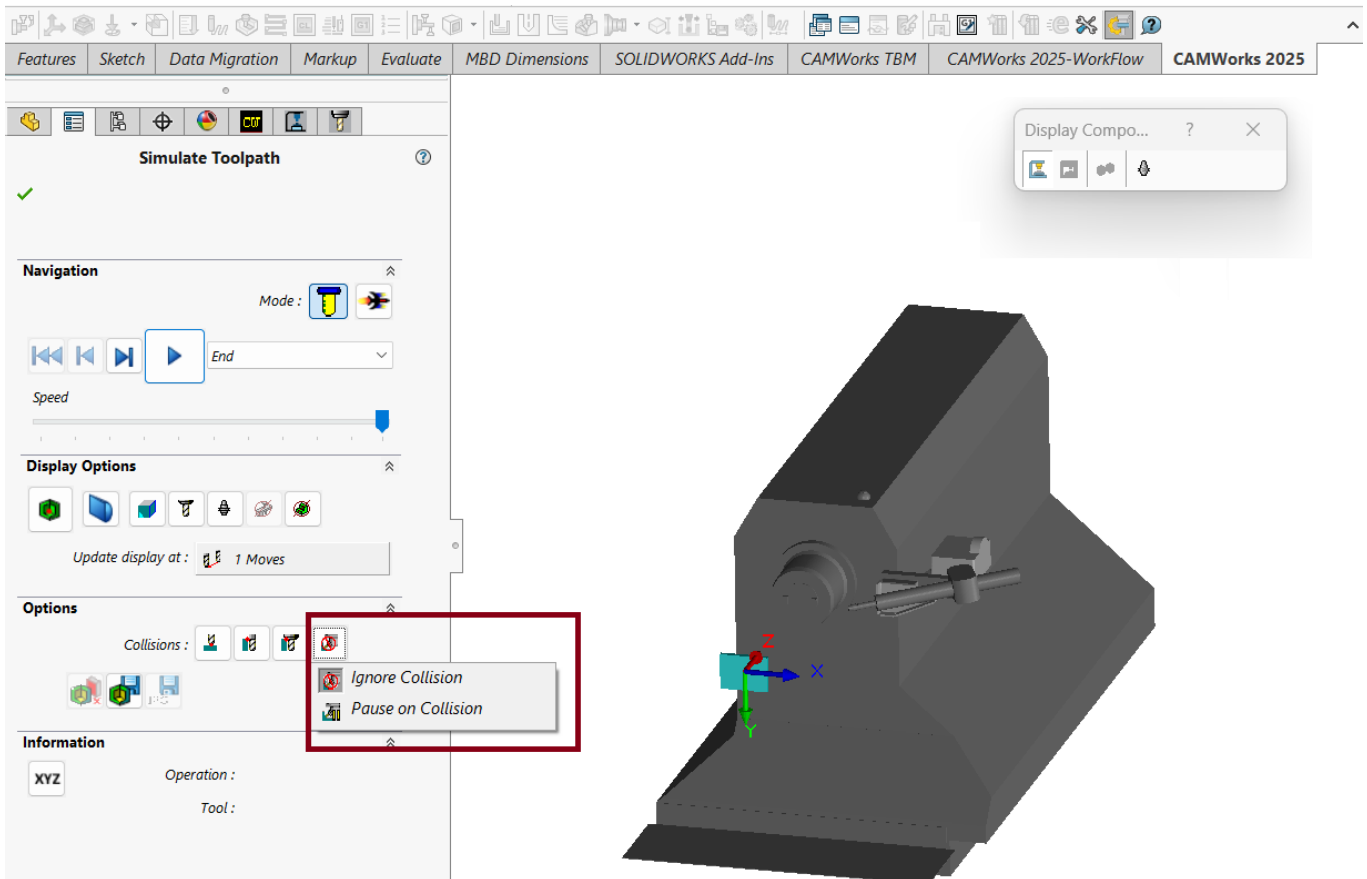

**Collision Detection Buttons for for Machine Components in Simulate Toolpath Dialog Box (Mill Mode)**



# What's New in CAMWorks 2025 SP0

The screenshot shows the CAMWorks 2025 SP0 interface. The top ribbon includes tabs for Features, Sketch, Data Migration, Markup, Evaluate, MBD Dimensions, SOLIDWORKS Add-Ins, CAMWorks TBM, CAMWorks 2025-WorkFlow, and CAMWorks 2025. The main window displays the 'Simulate Toolpath' dialog box. The dialog is divided into several sections: Navigation (with playback controls and a speed slider), Display Options (with view icons and an update frequency of 30 Moves), Options (where the 'Collisions' section is highlighted with a red box, showing 'Ignore Collision' and 'Pause on Collision' buttons), and Information (with XYZ coordinate system and Operation/Tool fields). A 3D model of a machine component is shown in the center, with a coordinate system (X, Y, Z) overlaid. A 'Display Compo...' dialog box is also visible in the top right corner.

**Collision Detection Buttons for Machine Components in Simulate Toolpath Dialog Box (Turn Mode)**



## Mill

### **New - Chamfer Machining using Ball Nose, Hog Nose, and Lollipop Tools**

**Purpose:**

To provide an option to select a Ball Nose, Hog Nose, or Lollipop tools for Chamfer Machining in Contour Mill operations.

**Implementation:**

In previous versions of *CAMWorks*, for the chamfer machining operations, only the following tools could be assigned:

- Countersink Tools
- Drill Tools
- Center Drill Tools
- Tapered End Mill Tools

From *CAMWorks 2025* version onwards, three additional tools will support chamfer machining. Following are the tools:

- Ball Nose Tools
- Hog Nose Tools
- Lollipop Tools

Following are sample images of chamfer machining operations generated using the Ball Nose, Hog Nose and Lollipop tools:

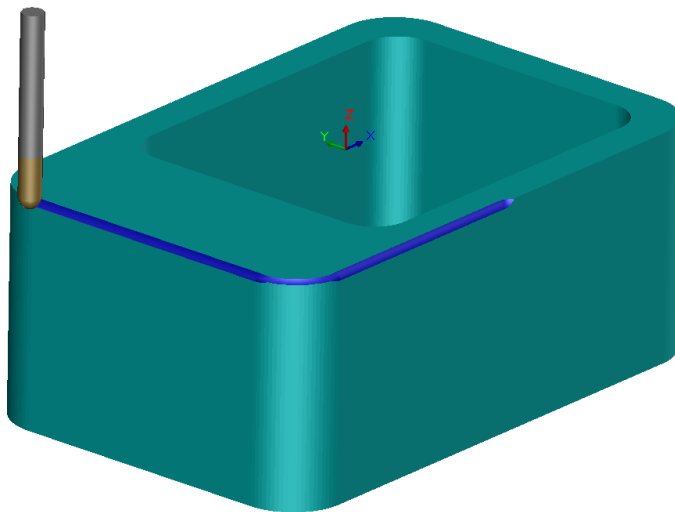

**Chamfer Machining using Ball Nose tool**

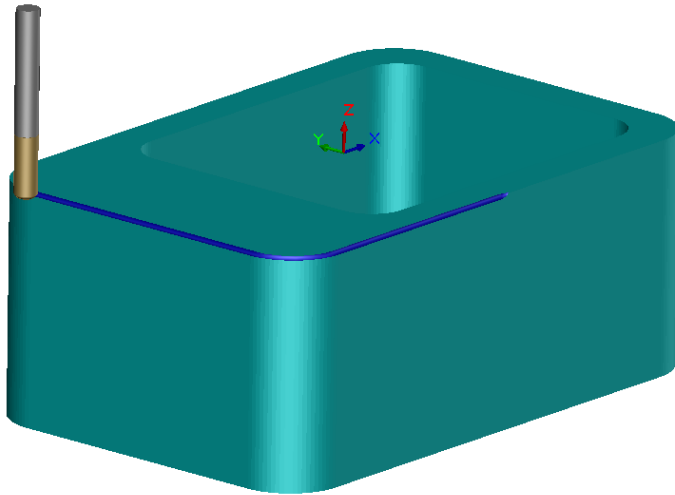

**Chamfer Machining using  
Hog Nose tool**

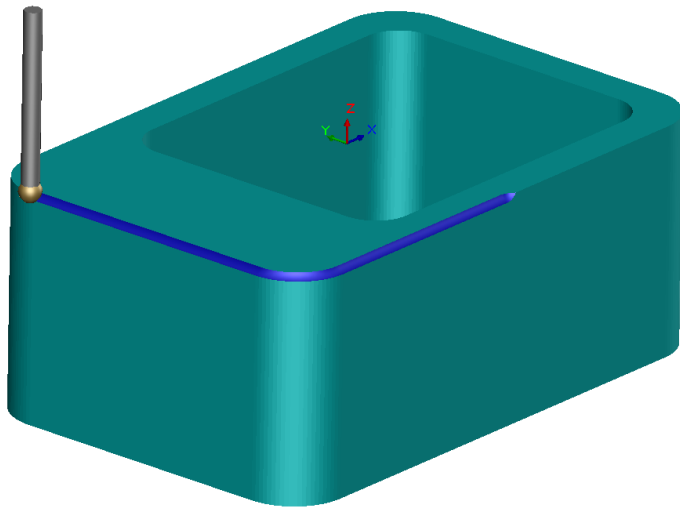

**Chamfer Machining using  
Lollipop tool**



# Turn/Mill-Turn

## **New - Options for Automatic Feature Recognition of Turn Features**

**Purpose:**

To provide options for recognizing Turn features in *CAMWorks* using *Automatic Feature Recognition*

**Implementation:**

In previous versions of *CAMWorks*, in Turn and Mill-Turn mode, there were no options for the user to select the Turn features to be recognized using Extract Machinable Features command. All the turn features in the part would get recognized by default.

Additionally, for part models machined on dual spindle machines (i.e., Main Spindle and Sub Spindle), there was no option to automatically create a Face Feature with Sub spindle attribute.

From *CAMWorks 2025* version onwards, these limitations have been eliminated by introducing checkbox options within **Feature types** group box under **Turn Features** tab of the *CAMWorks Options* dialog box. These checkbox options can be used to control which Turn Feature types are recognized automatically. One of these checkbox controls provides the option to generate Face Feature with Sub Spindle attribute.

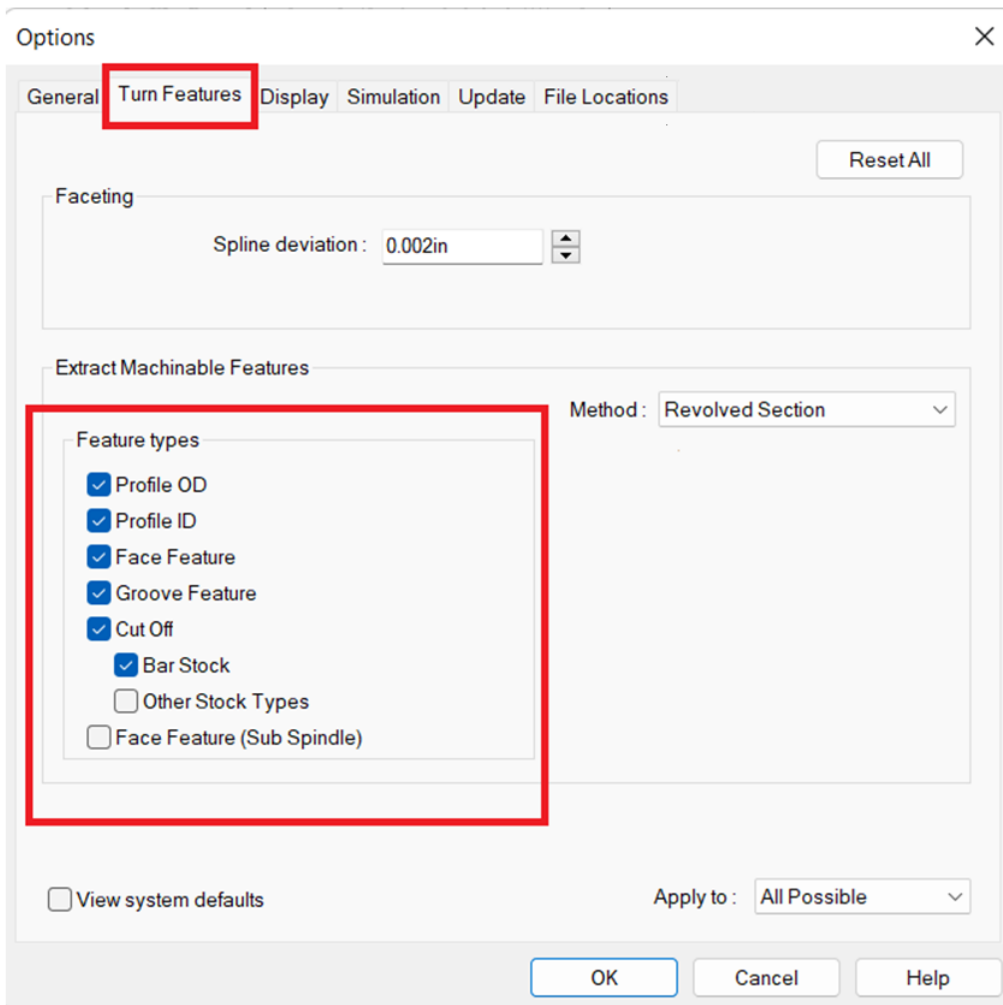

**Options within 'Feature Types' group box under 'Turn Features' Tab of 'Options' Dialog Box**

From *CAMWORKS 2025* version onwards, the turn features recognized and listed in the Feature tree will depend on these above checkbox settings within the *Turn Features* tab of *Options* dialog box.



**Behavior of Checkbox Options for Turn Features of type Profile OD, Profile ID, and Groove Feature)**

User can select the check boxes of the required feature type so that they are recognized through *Extract Machinable Features* command. By default, all the features will be set to ON.

**Behavior of Checkbox Option for Cut Off Feature**

The checkbox option for Cut Off feature has two nested checkbox options viz. **Bar Stock** and **Other Stock Types**.

Note that the Cut Off checkbox will get auto checked when you place a check in one or both these nested checkboxes. Conversely, if both the nested checkboxes are unchecked, then the *Cut Off* checkbox will be auto unchecked.

- If the *Stock type* is a *Bar Stock* and the *Bar Stock* option is checked, *Automatic Feature Recognition* will create a *Cut Off* feature under the same Turn setup as the other recognized features. When this checkbox option is unchecked, no *Cut Off* Feature will be generated.
- If the *Stock Type* is set to any other stock Type except the *Round Bar* stock type and the **Other Stock Types** checkbox option under the *Cut Off* feature is checked, then *Automatic Feature Recognition* will create a *Cut Off* feature under the same setup.

Depending on the stock type set in the stock manager, user can select one of these options. By default, both options will be set to ON.

**Behavior of Checkbox Option for Face Feature when Stock Type is a Bar Stock**

If the *Stock Type* is set to *Round Bar Stock* and the *Face Feature* checkbox option is checked, then *Automatic Feature Recognition (AFR)* will create a single face feature at the start of the part model. If unchecked, then no Face Feature will be created under the Turn Setup. You have the option to add the desired face feature interactively using *Interactive Feature Recognition*.

**Behavior of Checkbox Option for Face Feature when Stock Type is not a Bar Stock**

If the *Stock Type* is set to any other type except the *Round Bar Stock* and the *Face Feature* checkbox option is checked, then *Automatic Feature Recognition* will create the following two face features:

- Face Feature at the start of the part model. (This feature will be listed under the same Turn Setup as other recognized Turn features.)
- Face Feature at the end of the part model. (This feature will be listed under the reversed Turn Setup)

If unchecked, then no Face Feature will be created under the Turn Setup. You have the option to add the desired face feature interactively using *Interactive Feature Recognition*.

**Behavior of Checkbox Option for Face Feature (Sub Spindle)**

When this checkbox option is checked, *Automatic Feature Recognition* will create a Face feature at the end of the part (where *Cut Off* feature is generated) and list it under the same Turn Setup.

- If a dual spindle machine is selected and this checkbox option is checked, then the Spindle attribute of the newly recognized face feature will be set to Sub spindle.
- If the machine has only one Spindle (Main Spindle) and this checkbox option is checked, then the Spindle attribute will be set to Main spindle.

When this checkbox option is unchecked, no Face feature will be created at the location of Cut Off feature.



**New - Collets as Work Holding Device for Turn and Mill-Turn Machines**

**Purpose:**

To provide an option to define and assign a Collet as work holding device for the Main and/or Sub Spindles of Turn and Mill-Turn machines

**Implementation:**

As a clamping device, collets are capable of producing a high clamping force and accurate alignment.

In previous versions of CAMWorks, in Turn and Mill-Turn mode, only the *Standard* and user-defined chucks/fixtures were supported as work holding devices for Turn and Mill-Turn machines.

From CAMWorks 2025 version onwards, an option to define a Collet as the work holding device has been provided. CAMWorks will allow users to define and maintain a centralized library of collets in Technology Database (TechDB). The user will be able to assign a desired collet saved in the TechDB to the Turn/Mill-Turn machine selected for machining a part model/ assembly.



Sample Collet Image

**Machine Dialog Box**

In the Machine dialog box, the *Chuck/Fixture* tab has been renamed to *Fixture* tab. The *Shape* dropdown list within the *Main Spindle Information* and *Sub Spindle Information* under this tab is used to determine the type of work holding device. A new option *Collet* has been added to this dropdown list. Once this option is selected, the name of the collet assigned to the machine will be displayed in the *Name* field below the *Shape* dropdown list. (This default selection is based on the default collet assigned to the Machine in the TechDB.)

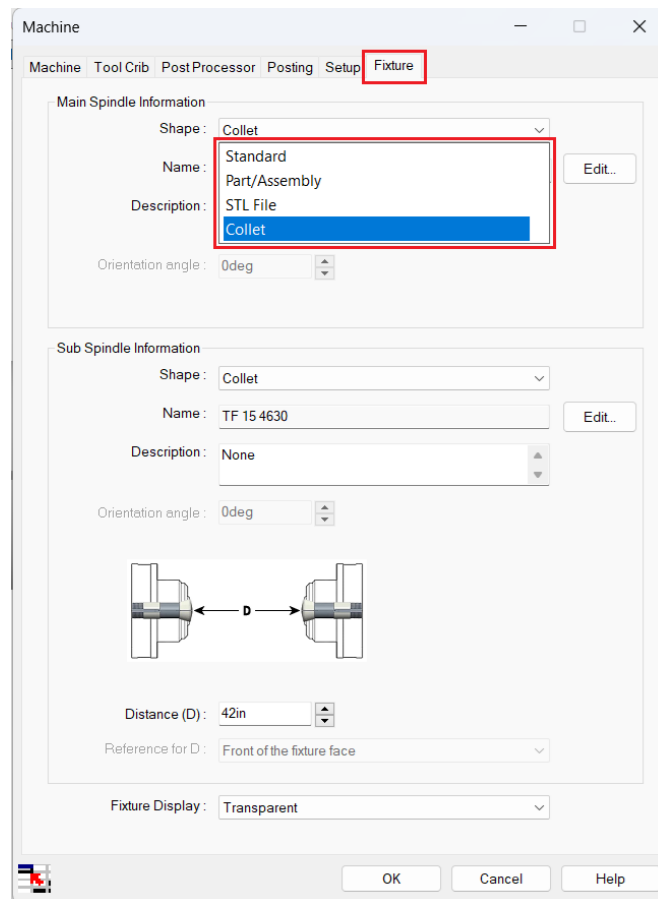

Collet option within the Shape dropdown list under Fixture tab of Machine dialog box



**Collet Parameter Dialog Box**

If you wish to assign another collet as the work holding device, then click on the **Edit** button adjacent to the *Name* dropdown list under the **Fixture** tab. Clicking on this command button will display the **Collet Parameter: Main/Sub Spindle Dialog Box**. Use the parameters and options available within this dialog box to:

- Change the collet type/style and corresponding collet selection
- Create new collets and optionally save them to the TechDB
- Edit the parameters of the selected collet

**Collet Parameter : [Main Spindle]**
?

✓
✗

---

**Collet Management** ⌵

Type/Style :

Available Collets :  ✗

Name :  📁

---

**Collet Parameters** ⌵

Stock Diameter (ID) :  ⬆️⬆️

Max Diameter (OD) :  ⬆️⬆️

Nose Diameter :  ⬆️⬆️

Face Diameter :  ⬆️⬆️

Taper Length :  ⬆️⬆️

Extension Length :  ⬆️⬆️

Overall Length :  ⬆️⬆️

---

**Collet Details** ⌵

Comment :

Vendor :

Description :

**Collet Parameter: Main/Sub Spindle dialog box displayed when Edit button is clicked**



# What's New in CAMWorks 2025 SP0

## Collets User Interface in TechDB

Within the TechDB, to invoke the **Collets** user interface, click on the *Collets* menu item under the **Holders & Assemblies** sub-menu of the Turn tooling menu.

The **Collets** user interface allows you to create a centralized library of collets. All collets saved within the TechDB are displayed in a tabular format within this interface. Saving collets in TechDB using this interface eliminates the need to define collets for individual Turn and Mill-Turn machines. It thereby allows you to automate the selection of collets as a work holding device for Turn and Mill-Turn machines in CAMWorks.

The screenshot displays the 'Collets' user interface within the CAMWorks 2025 Technology Database. The interface includes a sidebar with navigation options: Mill, Turn, Mill-Turn, EDM, Mill Tooling, Turn Tooling, Feed / Speed, Settings, and About. The main area shows a table of collets with the following data:

Id	Collet Name	Stock Diameter (I D)	Max Diameter(O D)	Nose Diameter	Face Diameter
1	TF 15 4630	0.0625	1.9685	1.9685	1.1811
2	TF 15 4631	0.125	1.9685	1.9685	1.1811
3	TF 15 4632	0.1875	1.9685	1.9685	1.1811
4	TF 15 4633	0.25	1.9685	1.9685	1.1811
5	TF 15 4634	0.3125	1.9685	1.9685	1.1811
6	TF 15 4635	0.375	1.9685	1.9685	1.1811
7	TF 15 4636	0.4375	1.9685	1.9685	1.1811
8	TF 15 4637	0.5	1.9685	1.9685	1.1811
9	TF 15 4638	0.5625	1.9685	1.9685	1.1811
10	TF 15 4639	0.625	1.9685	1.9685	1.1811
11	TF 15 4640	0.6875	1.9685	1.9685	1.1811
12	TF 15 4641	0.75	1.9685	1.9685	1.1811

The right-hand panel shows the details for 'Collet (ID: 1)'. The fields are as follows:

- Collet Name: TF 15 4630
- Stock Diameter (ID): 0.0625 in
- Max Diameter(OD): 1.9685 in
- Nose Diameter: 1.9685 in
- Face Diameter: 1.1811 in
- Taper Length: 0.3937 in
- Extension Length: 0.3937 in
- Overall length (L1): 5.9055 in
- Comment: NA
- Vendor: None
- Description: None

## Collets User Interface in CAMWorks TechDB



**New - Support for Bar Break Chamfering of the Stock in Turn Toolpaths**

**Purpose:**

To provide the option of adding Bar Break moves to Turn Toolpaths generated for OD features in order to prevent/eliminate burrs that can potentially damage the Guide Bushings

**Implementation:**

During the Turn toolpath machining process, burrs (unwanted sharp edges) are formed by the tool inserts when machining the edges of the cylindrical stock. Burrs can cause potential damage when the stock material slides through Guide Bushings.

From CAMWorks 2025 version onwards, to eliminate this issue of burr formation, the option to create additional moves called Bar Break moves has been provided for the following Turn toolpaths:

- Turn Rough
- Turn Finish
- Groove Rough (Only for OD features)
- Groove Finish (Only for OD features)
- Face Rough
- Face Finish

Adding Bar Break moves to the cut passes ensures that the stock edges are deburred and Guide bushing doesn't get damaged when the stock moves in and out of the Guide Bushing during the machining process.

**Bar Break Parameters under NC tab of Operation Parameters Dialog Box**

Parameters associated with the Bar Breaks functionality has been provided under the **NC** tab of the *Operation Parameters* dialog box of all these above operations.

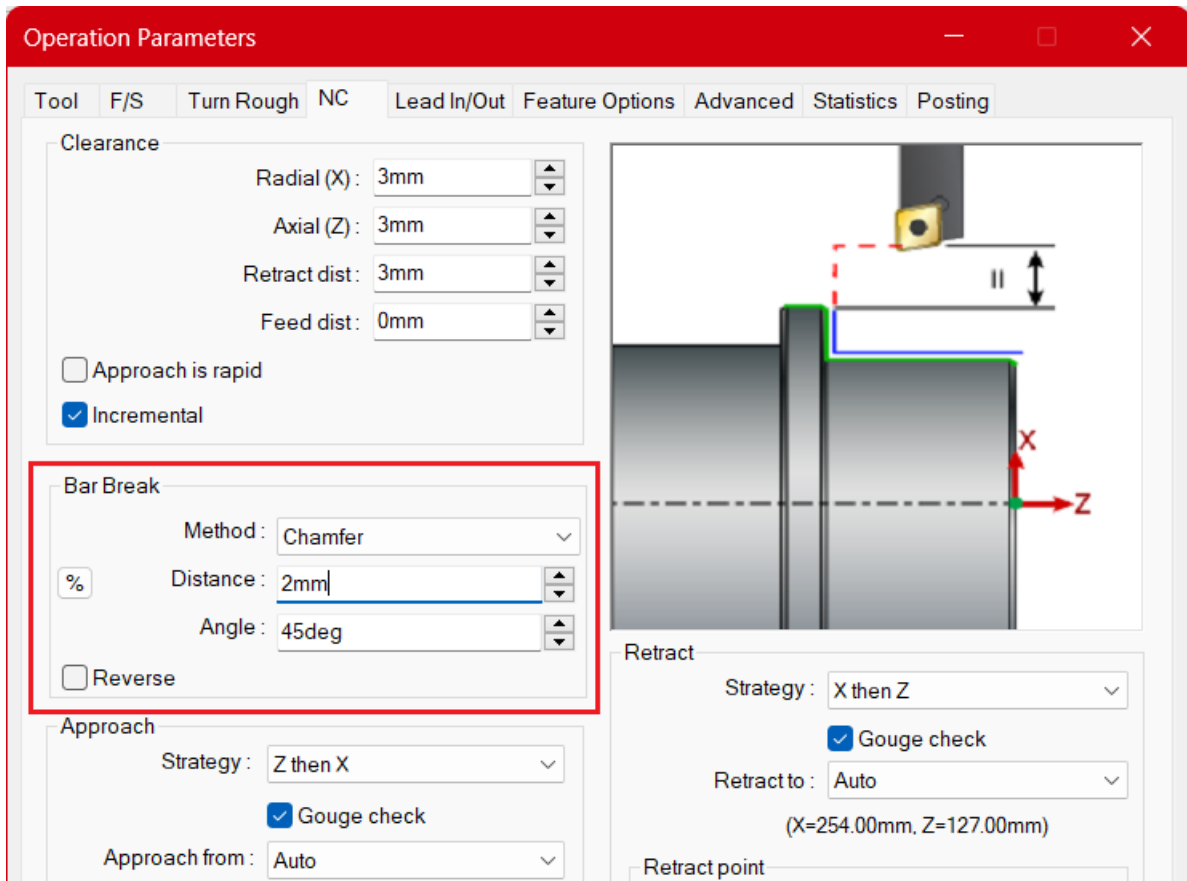

**Bar Break Parameters under NC Tab of Operation Parameters Dialog Box for Turn Rough Operation**



**Bar Break Options**

- By default, the **Bar Break Method** under the **NC** tab will be set to **None** i.e. no Bar Break moves.
- Select the **Chamfer** option in the **Method** dropdown list to add a chamfer to the sharp edges of the stock along the OD feature. Use the **Distance** and **Angle** parameters within the Bar Break group box to define the chamfer geometry.
- Select the **Radius** option in the **Method** dropdown list to add a fillet to the sharp edges of the stock along the OD feature. Use the **Distance** and **Radius** parameters within the Bar Break group box to define the fillet geometry.

**Addition of Bar Break Moves to Turning Toolpaths**

- For all the supported toolpaths, the Bar Break moves are added to the passes which intersect the max stock diameter. These moves are appended intelligently to the regular cut moves as and when needed.

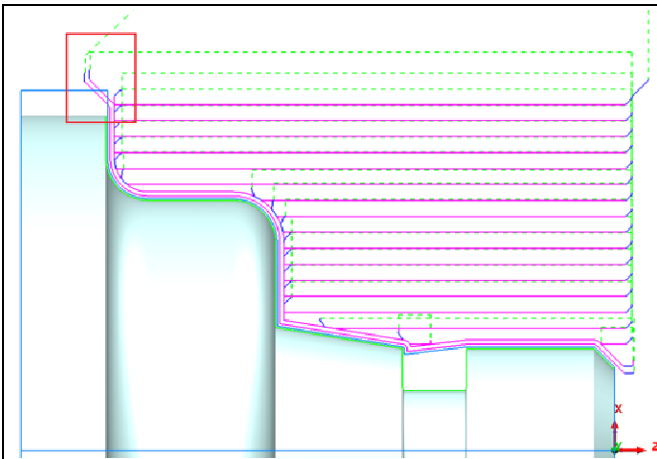

**Sample Turn Rough Toolpath with Bar Break Chamfers added to First Cut and Final Cut Passes**  
(The Bar Break moves are highlighted in a red rectangle.)

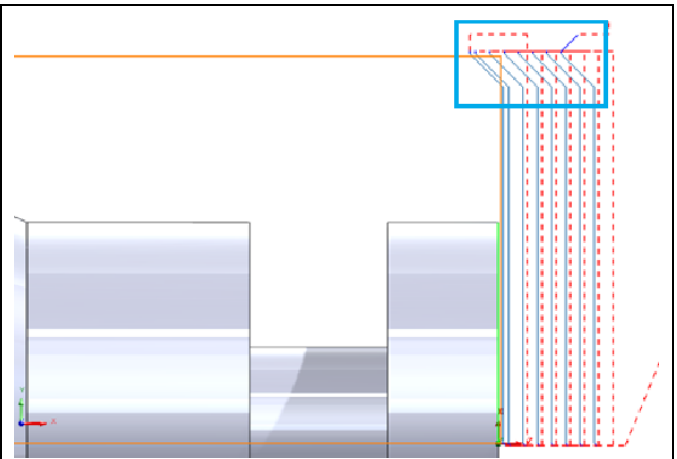

**Sample Face Rough Toolpath with Chamfer Bar Break moves for each Cut Pass**  
(The Bar Break moves are highlighted in the blue rectangle.)

- For the Groove Rough and Finish toolpaths, the Bar Break moves are added intelligently based on the groove style. The cutting pattern of the groove is considered for adding the bar break moves. There can be only one or multiple Bar Break moves depending on the groove style defined.

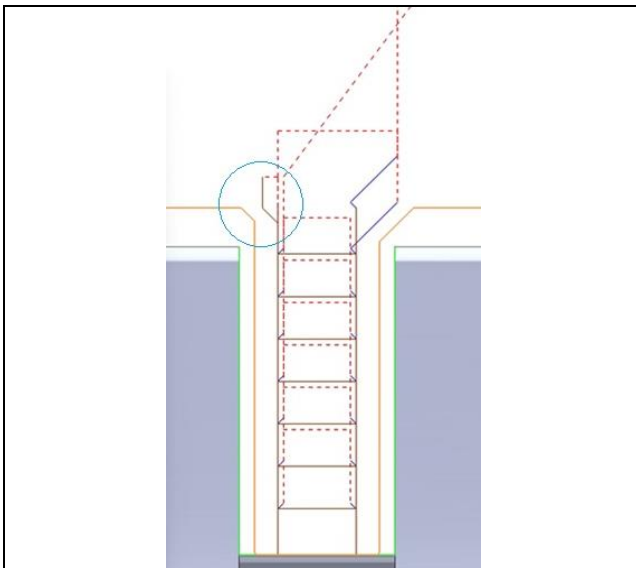

**Groove Rough Toolpath with 'Zig' Groove Style**  
(Bar Break Move highlighted in blue circle)

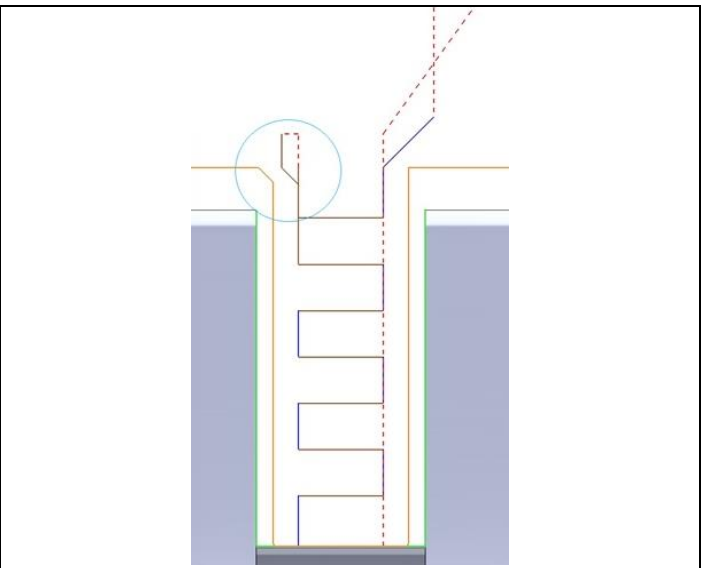

**Groove Rough Toolpath with 'Zigzag' Groove Style**  
(Bar Break Move highlighted in blue circle)

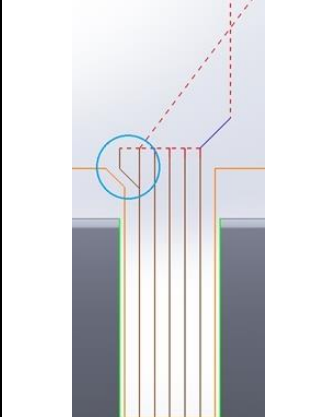
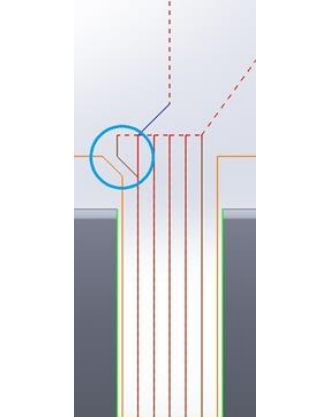
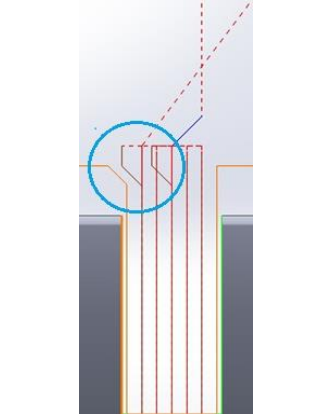
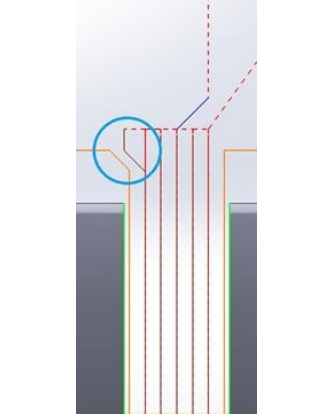

			
Groove Rough Toolpath Order: <b>S123</b> Groove Style: Normal Groove Peck Type: None	Groove Rough Toolpath Order: <b>S321</b> Groove Style: Normal Groove Peck Type: None	Groove Rough Toolpath Order: <b>S213</b> Groove Style: Normal Groove Peck Type: None	Groove Rough Toolpath Order: S231 Groove Style: Normal Groove Peck Type: None
Bar Break move added just before final cut pass.	Bar Break move added just before first cut pass.	Bar Break moves added before first cut and final cut passes.	Bar Break move added just before final cut pass.

**Reverse Option for Bar Breaks added to Turn Rough and Turn Finish Toolpaths**

Use the **Reverse** option within the **Bar Break** group box to cut the Bar Break move in a reverse fashion (i.e. the tool will approach the chamfer profile from max stock diameter and will machine it). Placing a check in the **Reverse** checkbox option will machine the Bar Break in the direction opposite to that of the cut passes.

The **Reverse** option is available only for *Turn Rough* and *Turn Finish* operations. However, this checkbox option will be disabled if the *Cut Type* under the *Turn Rough*/*Turn Finish* tab is reversed.

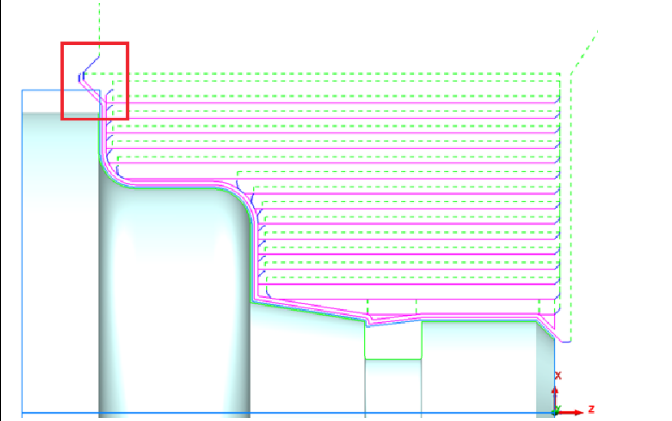
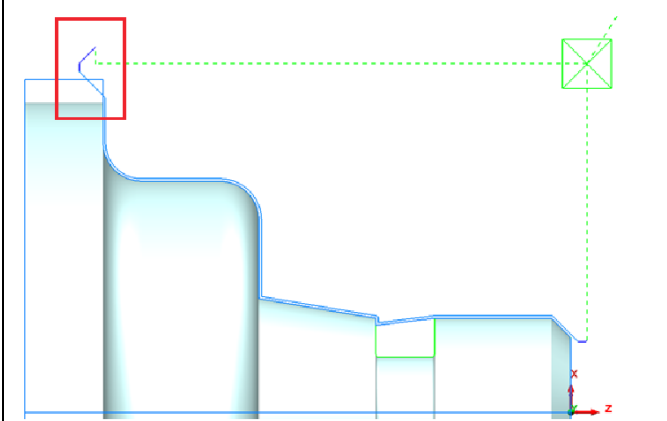
	
Sample Turn Rough Toolpath with Reversed Cut Type having Bar Break Chamfers added to First Cut and Final Cut Passes	Sample Turn Finish Toolpath with Reversed Cut Type having Chamfer Bar Break moves all Cut Passes

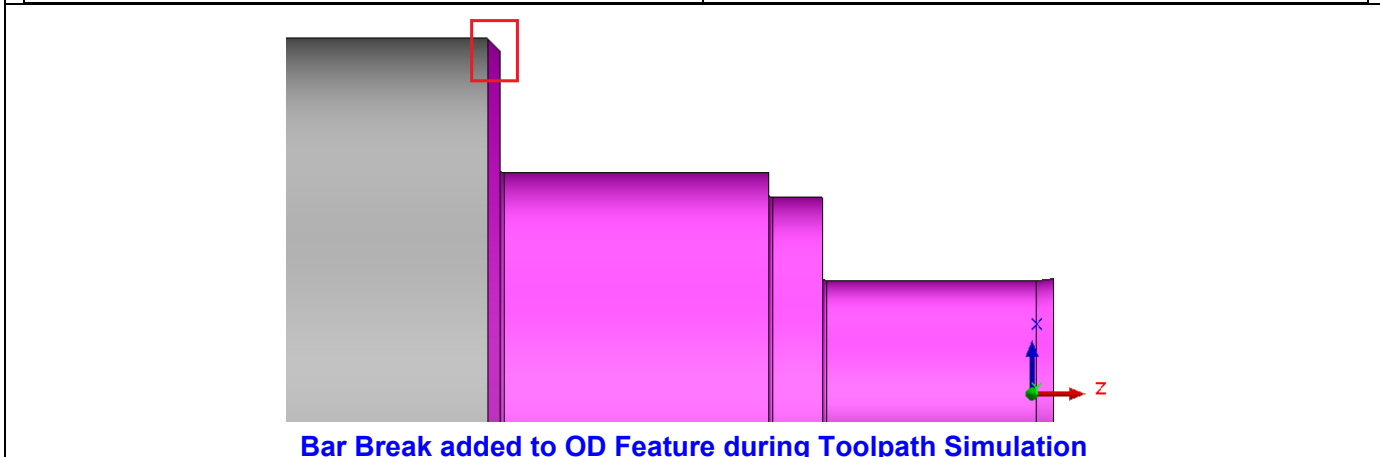



**New - Turret and Spindle Based Views for CAMWorks Sync Manager**

**Purpose:**

To provide options for expanded view of **Sync Manager** tab of the *CAMWorks Sync Manager* dialog box so that a complete visualization of the synchronized operations that includes Spindle data is possible

**Implementation:**

The *CAMWorks Sync Manager* enables users to visualize the synchronization of operations by sorting them into columns as per the turrets assigned to the tools used for the operations.

From *CAMWorks 2025* version onwards, the option for an expanded view of the **Sync Manager** tab of the *CAMWorks Sync Manager* dialog box has been provided. The view can be set as per turrets or as per spindles used by the operations. Such an option will assist in better visualization of the operations while synchronizing. This expanded view is highly recommended when operations are machined from both Main and Sub Spindles.

**New 'Sync Manager View' Group box under Sync Manager Tab of CAMWorks Sync Manager**

The options within the newly introduced **Sync Manager View** group box will be enabled only when the **Syncing Strategy** is set to *User Defined*. Place a check in the **Expand** checkbox within this group box to enable an expanded view of the synchronized operations within the **Sync Manager** tab. The following two options are available for the expanded view:

**'By Turret' Option**

The selection of this option enables an expanded view of the synchronized operations within the **Sync Manager** tab based on the Turret-Spindle combination. In each Turret-Spindle combination column, only the operations that have tools assigned from that specific turret and are machined on the specific spindle will be listed. The operations will be listed as per their machining sequence within each column. You can insert Wait codes before, after or, both before and after any two selected operations across different Spindle-Turret combinations to ensure synchronization of those selected operations.

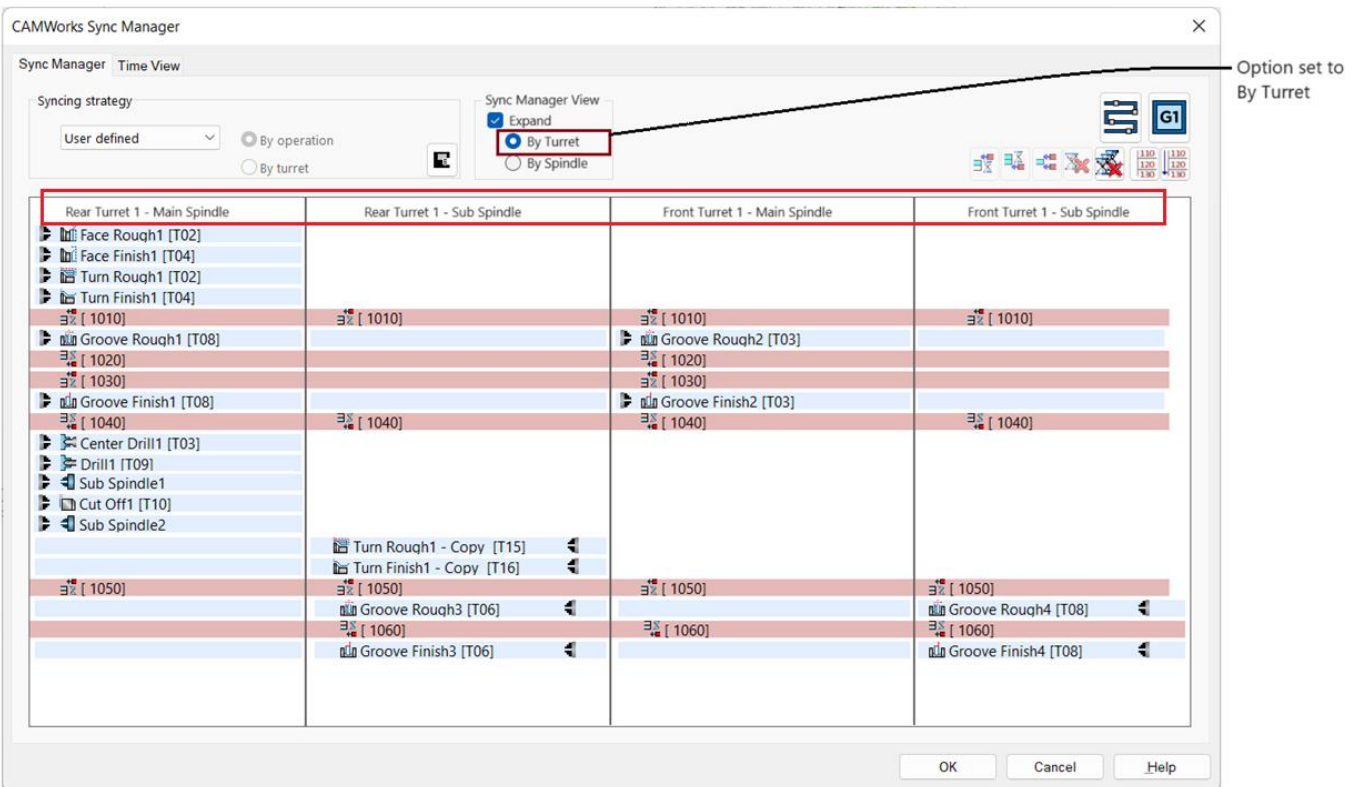

**Expanded View of Sync Manager Tab when 'By Turret' option is selected in Sync Manager View Groupbox**



**'By Spindle' Option**

The selection of this option enables an expanded view of the synchronized operations within the **Sync Manager** tab based on the Spindle-Turret combinations. In each Spindle-Turret combination column, only the operations that are machined on that specific spindle and have tools assigned from that specific turret will be listed. The operations will be listed as per their machining sequence within each column. You can insert Wait codes before, after or, both before and after any two selected operations across different Spindle-Turret combinations to ensure synchronization of those selected operations.

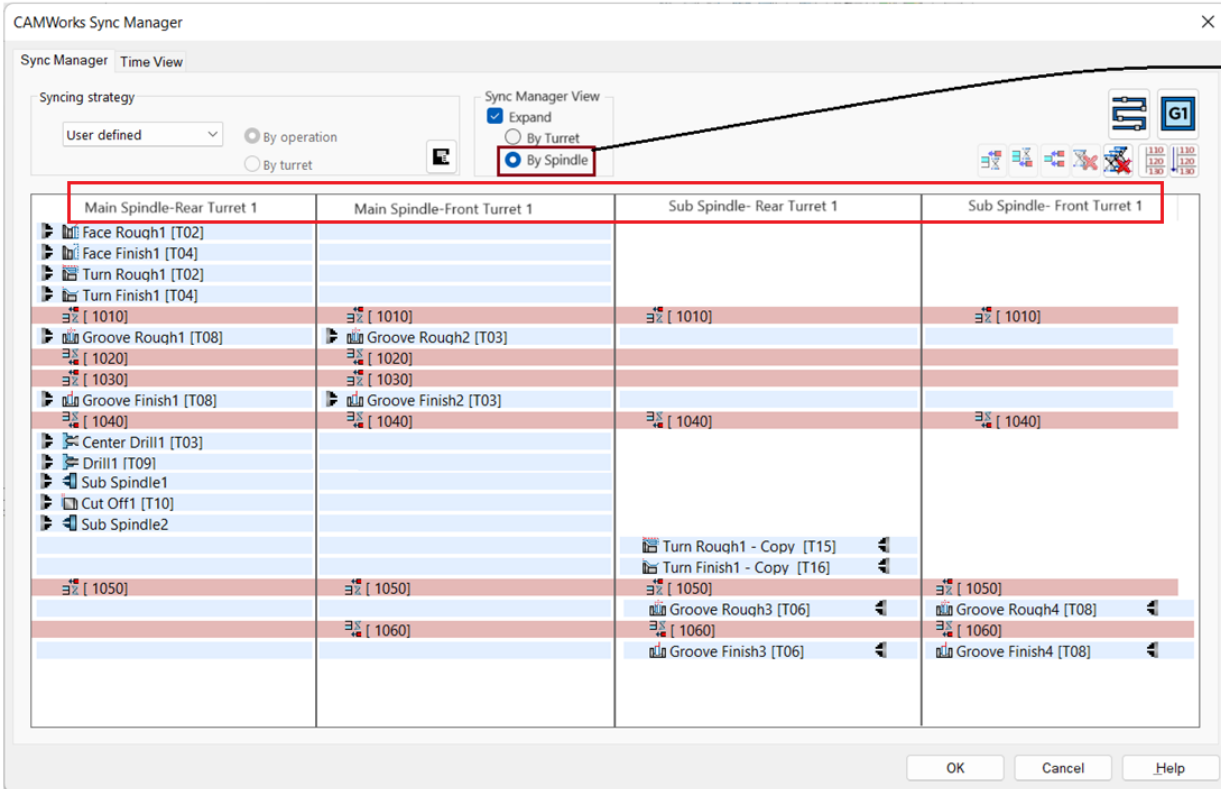

**Expanded View of Sync Manager Tab when 'By Spindle' option is selected in Sync Manager View Groupbox**



**New - Orientation for Mill Tools in Mill-Turn Tool Cribs**

**Purpose:**

To provide an option to define the orientation for Mill Tools in Mill-Turn tool cribs

**Implementation:**

In previous versions of *CAMWorks*, the option to define orientation was available only for Turn Tools in the corresponding *Holder/Boring Bar* page under *Tool* tab of the *Turn* operation.

In Mill-Turn tool cribs, the mill tools to machine the features on the OD or on the Face are setup in different ways. It is important to ensure that a tool with appropriate orientation is used for the Mill operations.

From *CAMWorks 2025* version onwards, tool orientation can be defined for Mill tools present in Mill-Turn Tool cribs. Under the *Mill Holder* tab of a Mill tool, a new dropdown list labelled *Orientation* will be available for defining the orientation.

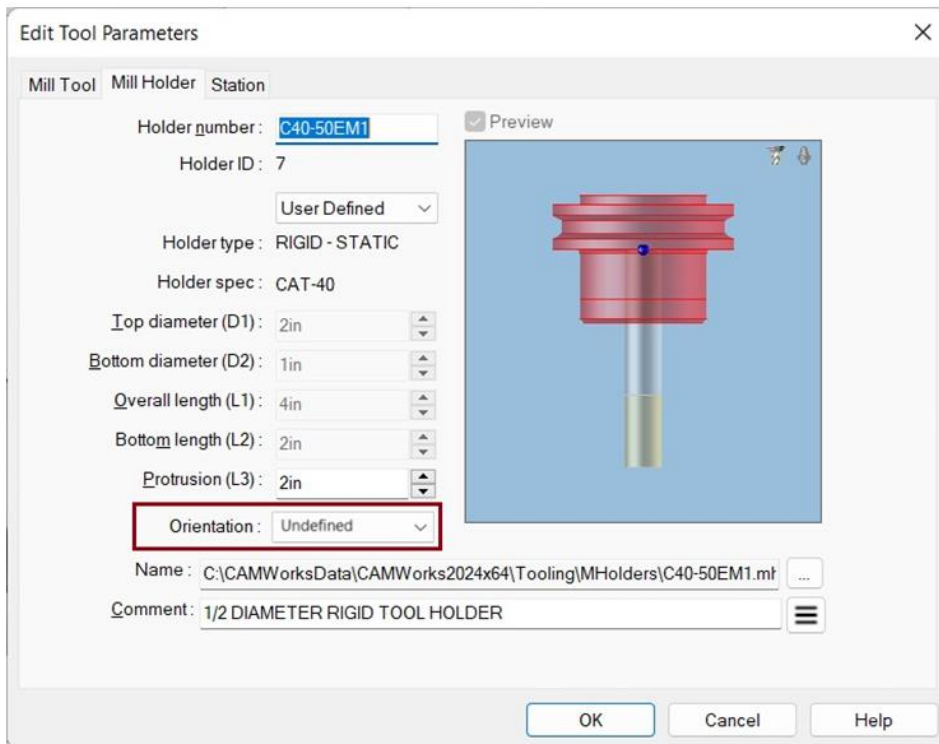

**Orientation dropdown list under Mill holder tab for a Mill tool in a Mill-Turn Tool Crib**

The following orientation options are available in this dropdown list:

- Left
- Down
- Right
- Up
- Undefined (Default option)

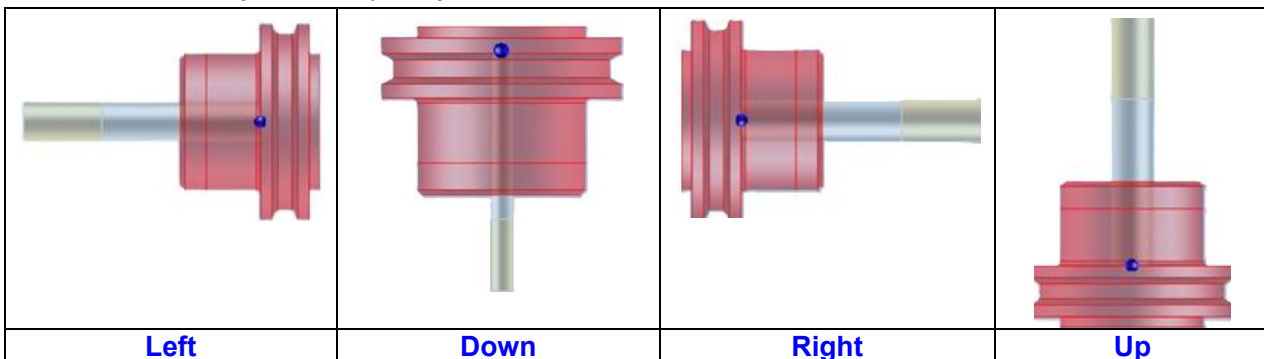



**Factors affecting Orientation of Mill Tools assigned to Operations**

In Mill-Turn mode, whenever any new operation auto-generated using the *Generate Operation Plan* command is assigned a Mill tool from the Mill-Turn tool crib, CAMWorks selects a Mill tool meeting the tool selection criteria and has the correct orientation to machine the selected feature.

The orientation criteria for the Mill tool is based on the following factors:

- **Spindle** on which the feature is being machined
- **Turret** in which the tool is loaded
- Whether the **Mill feature** being machined is on the OD profile or is a Face feature

The table given below indicates the proper orientation that will be assigned to a Mill tool in the Mill-Turn tool crib.

Spindle	Turret	Orientation for Feature Location on OD	Orientation for Machining Face Feature
Main Spindle	Rear	Down	Left
Main Spindle	Front	Up	Left
Sub Spindle	Rear	Down	Right
Sub Spindle	Font	Up	Right

**Note:**

Only mill tools having appropriate orientation can be assigned to operations. For example, a Mill tool with **Down** orientation can be assigned only to machine features on OD and not on a face.

**Assigning Default Orientation of Mill Tools present in Mill-Turn Tool Cribs saved in TechDB**

The orientation of the Mill tools can be set in the Mill-Turn tool cribs saved in the TechDB.

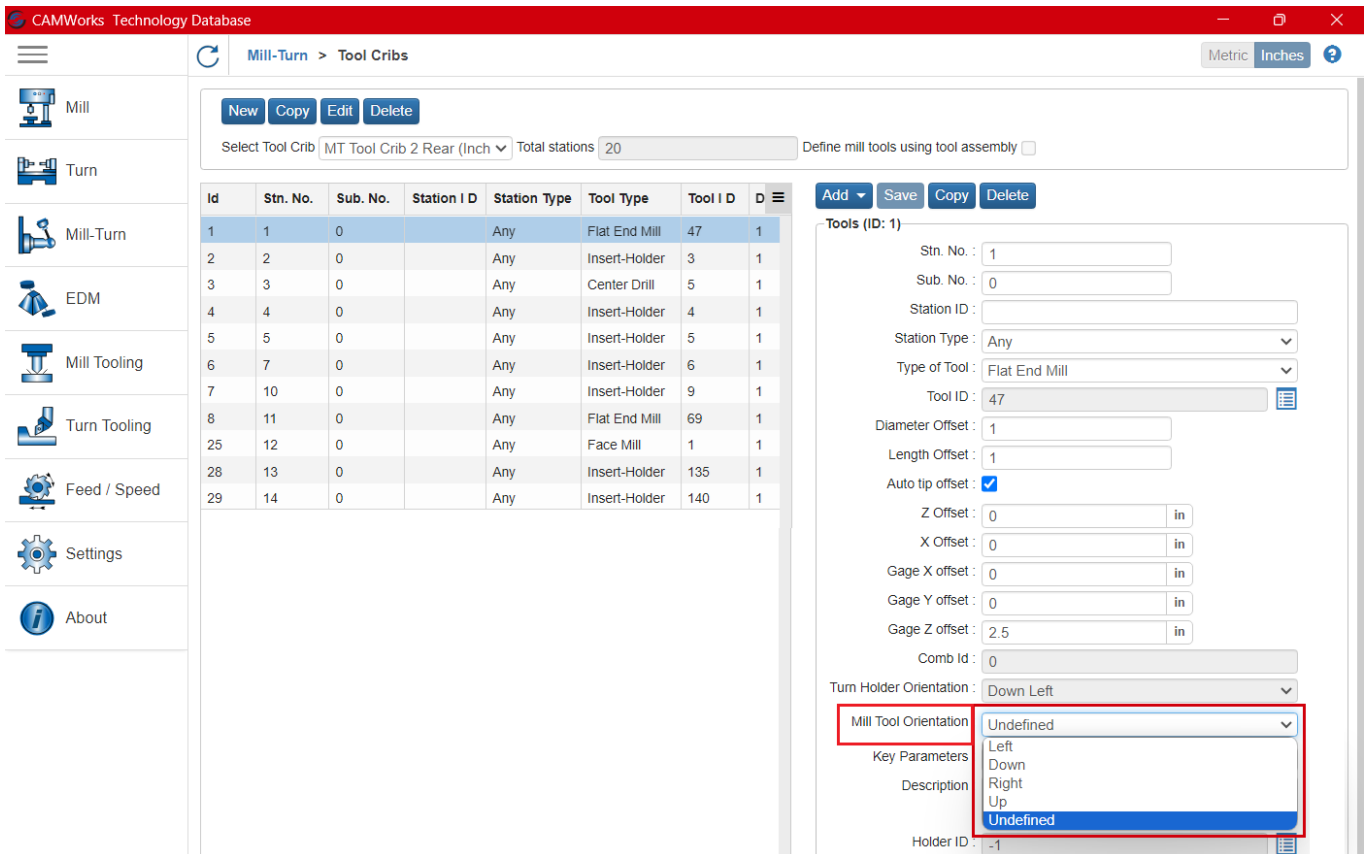

**New 'Mill Holder Orientation' Parameter in Tools Form of Mill-Turn Tools Cribs UI**